

End position controllers SPC11

FESTO



- Soft Stop
- Electronic end-position cushioning
- Freely selectable intermediate positions

End position controllers SPC11

Key features

FESTO

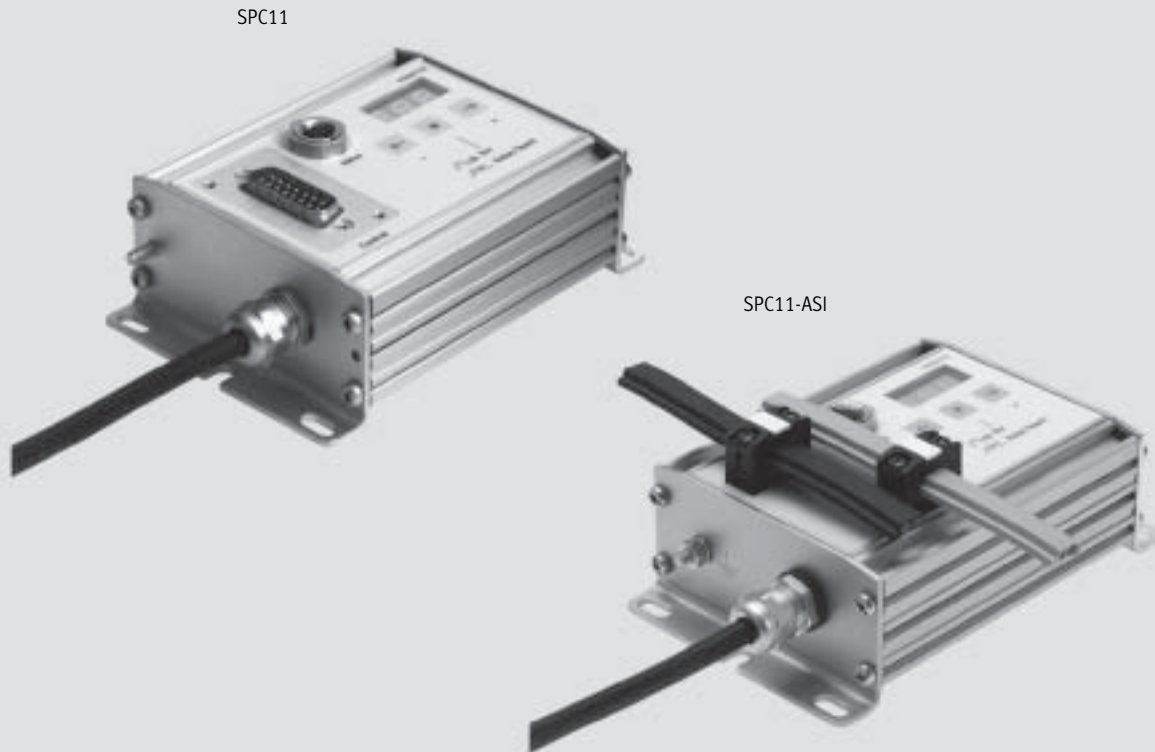

Pneumatic drives with end position controller (Soft Stop system)

Fast travel between two fixed stops with electronically controlled end-position cushioning and up to two freely selectable intermediate positions.

Recommended for the drives:

- DGP, DGPL
- DGPI, DGPII
- DNC, DNCM
- DSMI

- Up to 30% faster cycle rate.
- Significantly reduced system vibration.
- Optimum operating behaviour is maintained even with weight/load fluctuations of up to 30% of the total moving mass.
- Simple conversion of existing systems.
- Reduced noise level.
- Fast, problem-free commissioning, no specialists required.
- Less expensive than electro-mechanical drives.

End position controllers SPC11

Key features

Possible combinations

with external displacement encoder

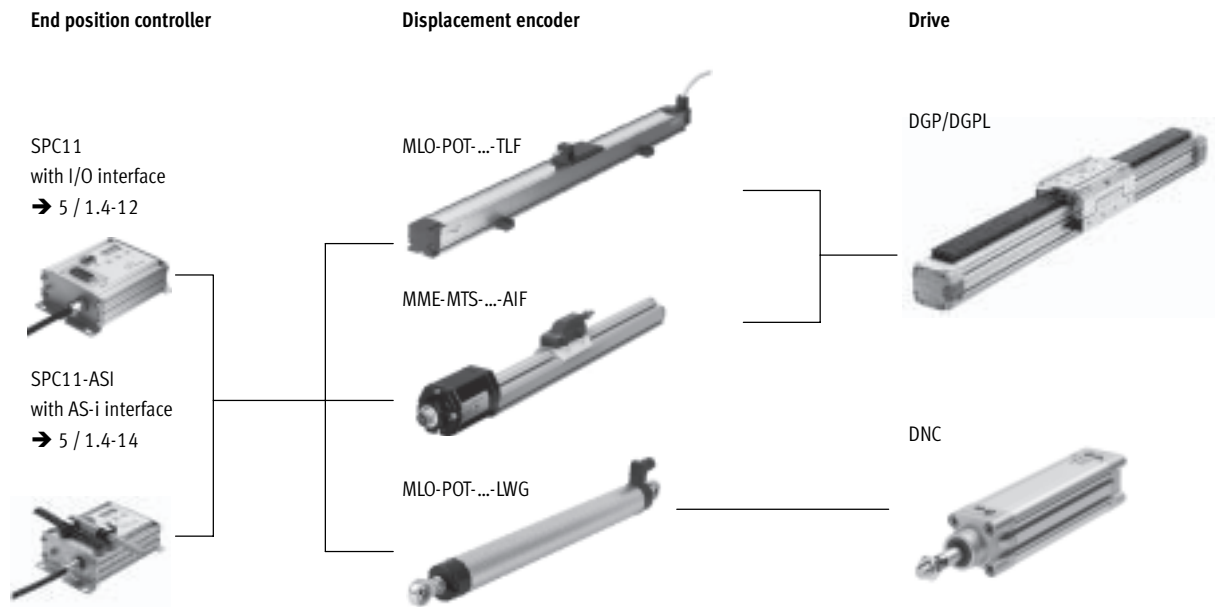

with integrated/adapted displacement encoder

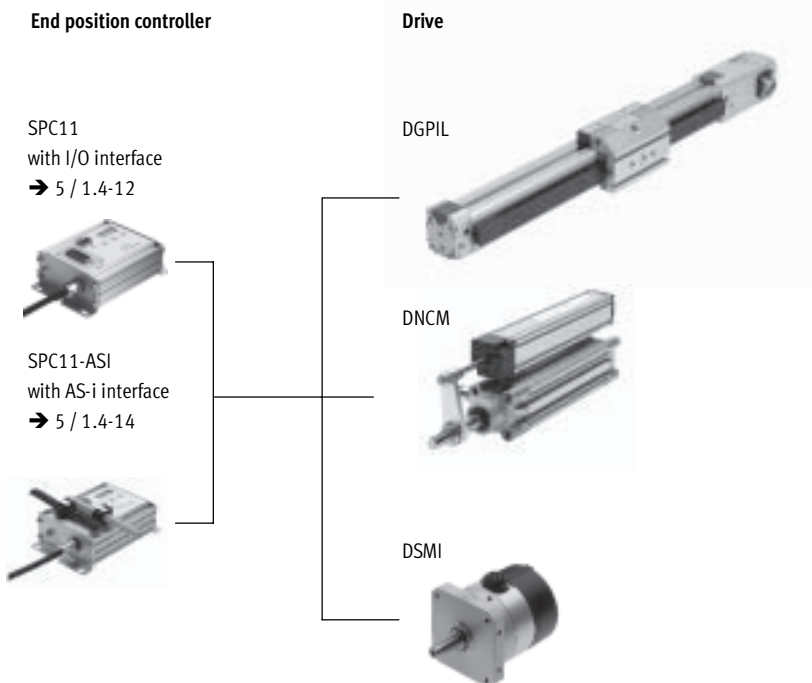

End position controllers SPC11

Peripherals overview

Variant with drive DGPIIL

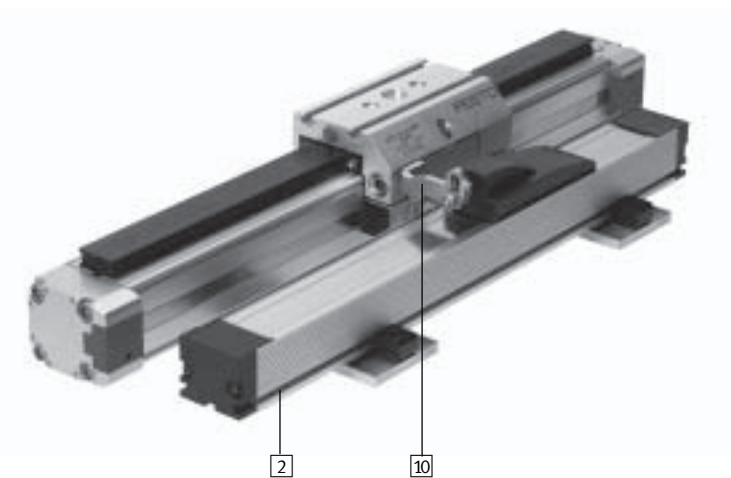
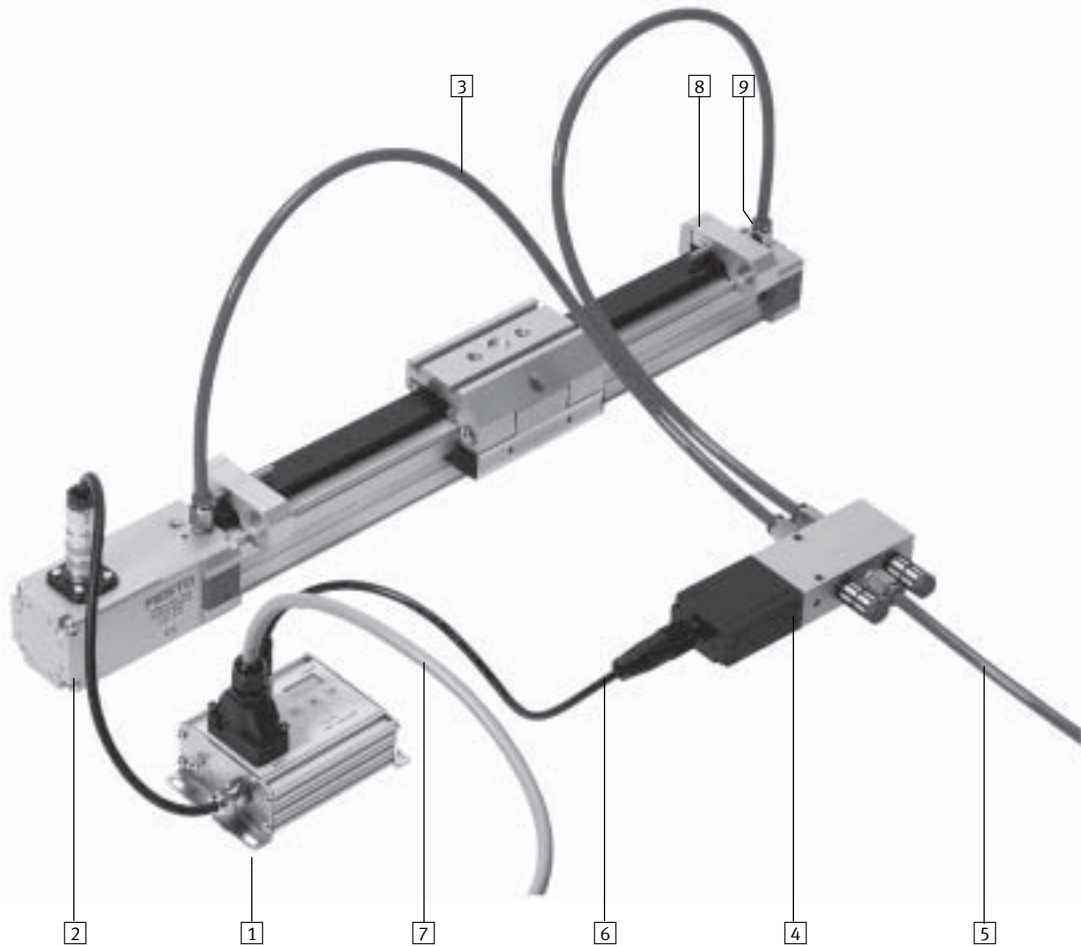

-  - Note

The same components are required for the drive DGPL as for the drive DGPIIL.

The integrated digital displacement encoder of the DGPIIL is replaced by an externally mounted displacement encoder (either digital or potentiometric).

End position controllers SPC11

Peripherals overview

Individual components					
Brief description	Pneumatic drives				
	DGP/DGPL	DGPI/DGPIL	DNC	DNCM	DSMI
1 End position controller SPC11	■	■	■	■	■
1 End position controller SPC11-ASI	■	■	■	■	■
2 Analogue displacement encoder MLO-POT-...-TLF	■	-	-	-	-
2 Analogue displacement encoder MLO-POT-...-LWG	-	-	■	-	-
2 Digital displacement encoder MME-MTS-...-AIF	■	-	-	-	-
3 Air supply lines (laid symmetrically)	■	■	■	■	■
4 Proportional 5/3-way valve MPYE	■	■	■	■	■
5 Compressed air supply	■	■	■	■	■
6 Connecting cable KMPYE to proportional 5/3-way valve	■	■	■	■	■
7 Connecting cable to controller	■	■	■	■	■
8 Fixed stop	■	■	1)	1)	■ 2)
9 Push-in connector QS (preferably straight)	■	■	■	■	■
10 Displacement encoder mounting kit	■	-	-	-	-
Package solutions →	5 / 1.4-16	5 / 1.4-16	5 / 1.4-22	5 / 1.4-26	5 / 1.4-32

1) External limit stops are required with the DNC and DNCM to limit the travel distance within the effective stroke.

2) External limit stops are required when using the swivel module DSMI so that the nominal swivel angle can be used as the effective swivel angle (270°). Internal limit stops can be used if the effective swivel angle is smaller than the nominal swivel angle.

Allocation of end position controller SPC11 to drive and displacement encoder			
End position controller	SPC11-POT-TLF SPC11-POT-TLF-ASI	SPC11-POT-LWG SPC11-POT-LWG-ASI	SPC11-MTS-AIF SPC11-MTS-AIF-ASI
Drive			
DGPI/DGPIL	-	-	■
DNCM	■	-	-
DSMI	-	■	-
Displacement encoder			
MLO-POT-TLF	■	-	-
MLO-POT-LWG	-	■	-
MME-MTS-AIF	-	-	■

End position controllers SPC11

Key features

FESTO

Conventional solution

Previously you needed to

- Harmonise individual components.
- Install additional shock absorbers and possibly replace/exchange existing shock absorbers.
- Fit proximity sensors for position detection.
- Adjust the compressed air supply by means of flow control valves in order to optimise the system.

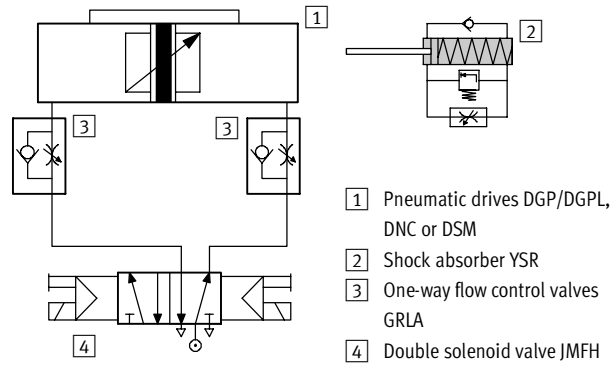

Until now, to create intermediate positions you had to

- Construct a complex mechanical solution using stopper cylinders, for example.
- Harmonise a large number of individual components.
- Perform extensive programming.

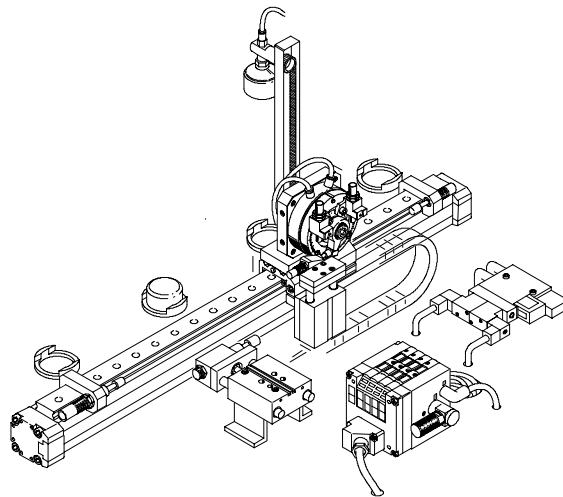

Solution with end position controller SPC11

Fast travel between two fixed stops with up to two freely selectable intermediate positions

The Soft Stop system with end position controller SPC11 allows travel between two fixed mechanical stops as well as travel to up to two freely selectable intermediate positions. The level of accuracy of the intermediate positions is $\pm 0.25\%$ of

the displacement encoder length, and no less than ± 2 mm. The level of accuracy of the intermediate positions is $\pm 2^\circ$ for swivel module DSML. Typical applications for the intermediate positions are rest or ejector positions, where a low cost solution is more

important than achieving high levels of accuracy. The intermediate positions also have sensor functionality. This means that when the relevant intermediate position is passed, a 1 signal is produced at the corresponding output for 50 ms.

End position controllers SPC11

Key features

The Festo package solution

Soft Stop with end position controller SPC11

In an application with up to two intermediate positions you can now:

- Use the Festo package solution with a small number of harmonised components.
- Dispense with complex constructions with stopper cylinders.
- Approach the intermediate positions from both sides.
- Let optimisation be carried out by the learning system itself.

The Soft Stop system with SPC11 has a remote input, which allows all three pushbuttons to be allocated to a master controller:

- All system parameters can be defined and changed externally.
- A 1 signal at the remote input locks all pushbuttons on the end position controller SPC11.

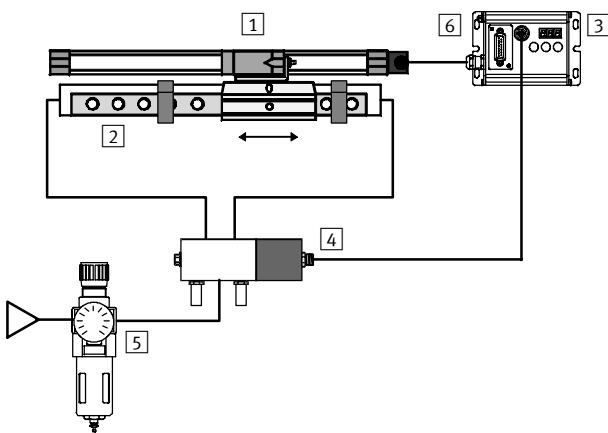

- 1** Displacement encoder
Digital:
– MME-MTS-...-AIF
– integrated in case of DGPI/DGPIL
Analogue:
– MLO-POT-...-TLF
– MLO-POT-...-LWG
– integrated in case of DSMI
- 2** Pneumatic drives
DGP/DGPL, DGPI/DGPIL, DNC, DNCM or DSMI

- 3** End position controllers
SPC11-POT-TLF,
SPC11-POT-LWG or
SPC11-MTS-AIF
- 4** Proportional 5/3-way valve
MPYE-5-...-010B
- 5** Service unit (without lubricator, with 5 µm filter); supply pressure 5 to 7 bar
- 6** Operating voltage connection and master controller

Soft Stop with end position controller SPC11-ASI

SPC11 with AS-i interface offers the same drive functionality as the end position controller SPC11 with digital I/O interface.

The AS-i interface can be used in two operating modes. These are as follows:

- 4-bit standard I/O mode:
 - The order to advance to the four positions is given by the ASI master via the four data bits.
 - The SPC11-ASI is started up via pushbuttons on the end position controller. Connecting the ASI cable locks these pushbuttons; the positions can then be approached via ASI.

- Slave 7.4 as per ASI specification 2.1:
 - All startup activities take place via the AS-interface.
 - Error numbers are read out and errors are acknowledged via the AS-interface.
 - Absolute values are transferred for the intermediate positions.
 - The Soft Stop axis can be moved manually via pushbuttons on the console.

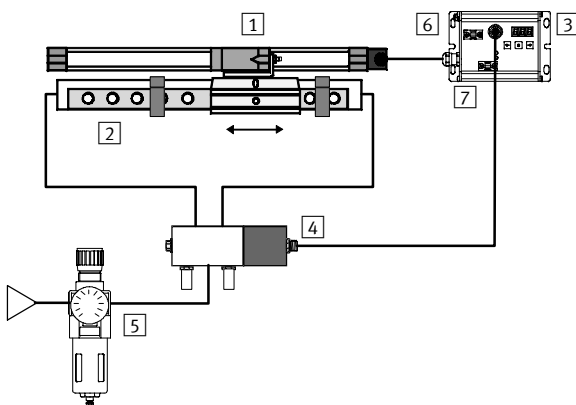

- 1** Displacement encoder
Digital:
– MME-MTS-...-AIF
– integrated in case of DGPI/DGPIL
Analogue:
– MLO-POT-...-TLF
– MLO-POT-...-LWG
– integrated in case of DSMI
- 2** Pneumatic drives
DGP/DGPL, DGPI/DGPIL, DNC, DNCM or DSMI

- 3** End position controllers
SPC11-POT-TLF-ASI,
SPC11-POT-LWG-ASI or
SPC11-MTS-AIF-ASI
- 4** Proportional 5/3-way valve
MPYE-5-...-010B
- 5** Service unit (without lubricator, with 5 µm filter); supply pressure 5 to 7 bar
- 6** Load voltage (black cable)
- 7** Logic voltage (yellow cable)

End position controllers SPC11

Key features

End position controllers

Integrated functions:

- Sensing of system data of connected components.
- Storage of desired end positions or intermediate positions.
- Comparison of setpoint and actual position, and position control by appropriate activation of the proportional 5/3-way valve (status control).
- Internal or external teach-in function.

SPC11



Technical data and dimensions

→ 5 / 1.4-12

SPC11-ASI



→ 5 / 1.4-14

Analogue displacement encoders

Analogue displacement encoder based on a conductive-plastic linear potentiometer. The system measures absolute values. It is connected alongside a pneumatic linear drive. Mounting kits are available as accessories for the mechanical coupling. The displacement encoder is available in fixed stroke lengths ranging from 100 ... 2000 mm.

MLO-POT...-TLF



Technical data and dimensions

→ 5 / 1.2-2

MLO-POT...-LWG



→ 5 / 1.2-2

Mounting kits

→ 5 / 1.2-11

Digital displacement encoders

Digital displacement encoders, magnetostrictive, contactless method of measurement. The system measures absolute values. It is connected alongside a pneumatic linear drive. Mounting kits are available as accessories for the mechanical coupling. The displacement encoder is available in fixed stroke lengths ranging from 100 ... 2000 mm.

MME-MTS...-AIF



Technical data and dimensions

→ 5 / 1.2-2





Mounting kits



→ 5 / 1.2-11

End position controllers SPC11

Key features

FESTO

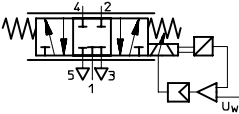
Pneumatic drives		Technical data and dimensions	
<p>Pneumatic linear drives ensure an easy-to-operate system. The stroke length operating range depends on the selected drive. The range extends from 225 ... 2000 mm. The swivel angle range with DSMI extends from 0° ... 270°.</p>	<p>DGP/DGPL DGPI/DGPIL</p> 	<p>→ 5 / 1.1-20 → 5 / 1.1-38</p>	<p> Note</p> <p>The drives DGP/DGPL with compressed air supply connections at both ends (D2) should be used for nominal cylinder strokes above 600 mm. Festo's current package solutions are based on the drives DGP/DGPL, DGPI/DGPIL, DNC, DNCM and DSMI.</p>
	<p>DNC</p> 	<p>→ Volume 1</p>	
	<p>DNCM</p> 	<p>→ 5 / 1.1-4</p>	
	<p>DSMI</p> 	<p>→ 5 / 1.1-74</p>	

Proportional 5/3-way valves		Technical data and dimensions	
 <p>Valve actuation is through the end position controller. The valve controls the volume of air supplied to the drive. The extremely short switching time of the valve makes the Soft Stop package solution highly dynamic.</p>	<p>MPYE-5-...-010B</p> 	<p>→ 5 / 1.5-1</p>	<p> Note</p> <p>Use a 5 µm filter for air preparation. The compressed air supply must be unlubricated.</p>

End position controllers SPC11

Key features

The solution package

Individual components

- Pneumatic drives
DGP/DGPL, DGPI/DGPIL, DNC,
DNCM or DSMI
- Proportional 5/3-way valve
MPYE-5-...-010B
- Displacement encoder
MLO-POT-...-TLF,
MLO-POT-...-LWG or
MME-MTS-...-TLF-AIF

- End position controllers
SPC11 or SPC11-ASI
- Valve cable
KMPYE
- Controller cable
KMPV-... or KASI-...
- Manual

Package solutions are uniquely defined, i.e. all components are harmonised for optimum performance. For details of this unique allocation please see → 5 / 1.4-17 or 5 / 1.4-33 or
→ Soft Stop software tool:
www.festo.com/en/engineering

Accessories available on separate order (fittings, tubing, etc.) can be found in the respective package solutions. An example of an order is shown on → 5 / 1.4-16 or 5 / 1.4-32.

Optimum system characteristics can be obtained only within the effective stroke of the cylinder.

PPV = Internal cushioning length

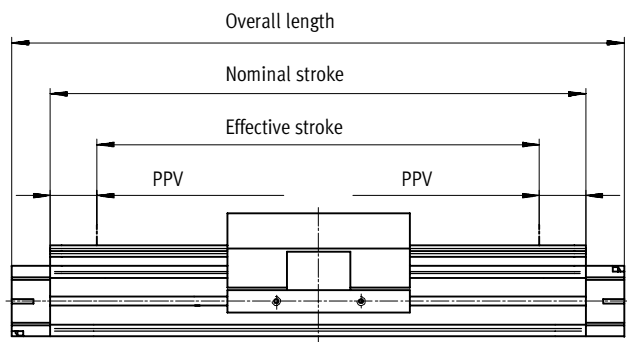

Symmetrical

The desired travel distance should not therefore exceed the relevant effective stroke.

The following thus applies:

Travel distance ≤ Effective stroke.

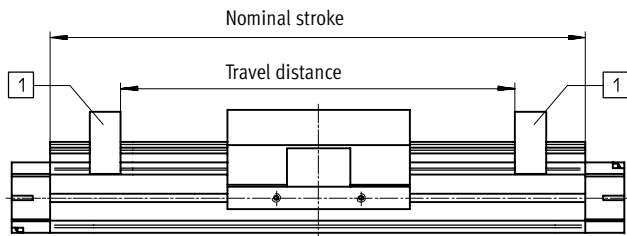

1 Fixed stops, mounted on drive or externally

Asymmetrical

The desired travel distance within the effective stroke must be limited by means of fixed stops. The same applies to the pneumatic drives DNC, DNCM and DSMI.

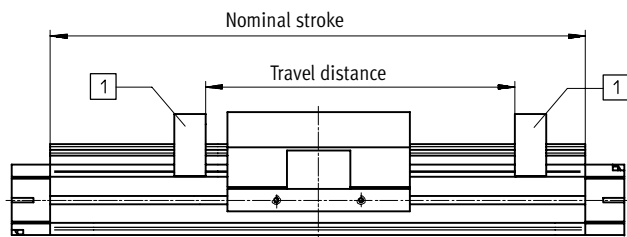

1 Fixed stops, mounted on drive or externally

 Note

External limit stops are required in order to have the nominal stroke as the effective stroke (or nominal swivel angle as effective swivel angle

in the case of DSMI) when using the pneumatic drives DNC, DNCM and DSMI with the Soft Stop system.

End position controllers SPC11

Key features

The solution package

Advantages

- Up to 30 % faster cycle rate.
- Significantly reduced system vibration.
- Optimum operating behaviour is maintained even with weight/load fluctuations of up to 30% of the total moving mass.
- Simple conversion of existing systems.
- Considerably reduced noise level.
- Fast problem-free commissioning, no specialists required.
- Less expensive than electro-mechanical drives.

The graphs apply to the following example:

- DGPL-25-1250-PPV-A-KF-B-GK-...-D2,
- Moving load: 12 kg,
- Horizontal mounting position

Note

The shape of the curve is identical for the pneumatic drives DNC, DNCM, DSMI and DGPII.

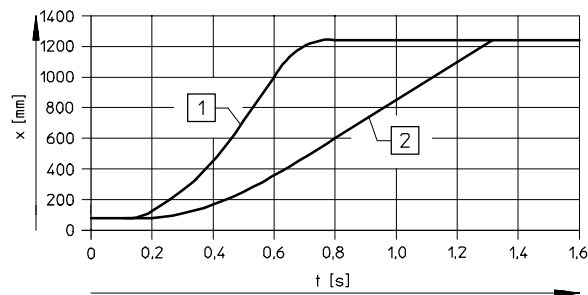

- 1 = Drive with electronic end position controller SPC11
- 2 = Drive with shock absorber

x = Travel distance
t = Time

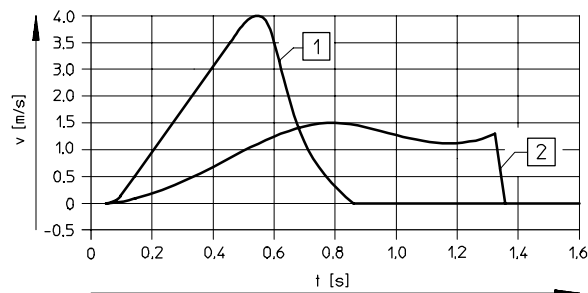

- 1 = Drive with electronic end position controller SPC11
- 1 = Drive with shock absorber

v = Velocity
t = Time

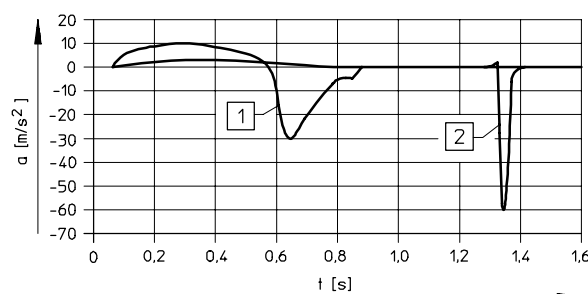

- 1 = Drive with electronic end position controller SPC11
- 2 = Drive with shock absorber

a = Acceleration
t = Time

End position controllers SPC11

Technical data

FESTO

Teach-in function

SPC11-POT-TLF
SPC11-POT-LWG
SPC11-MTS-AIF

The teach-in travel to determine the system data and end positions can be started by means of a button on the end position controller SPC11 or via an externally routed output which is connected by means of the control cable (e.g. the PLC).

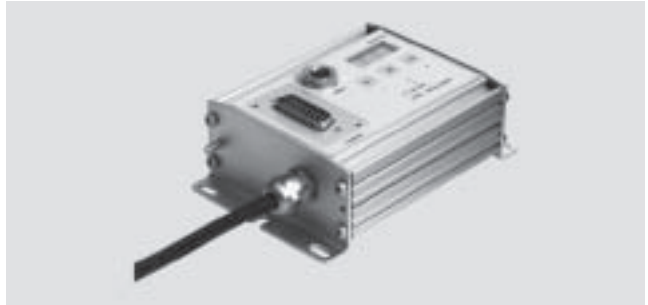

General technical data				
End position controller	Type	SPC11-POT-TLF	SPC11-POT-LWG	SPC11-MTS-AIF
Operating voltage	[V DC]	24 (-25 ... +25%)		
Current consumption	with valve	[A]	1.1	
	without valve	[mA]	70	170
Residual ripple	[%]	max. 6		
Digital inputs	Input voltage	[V DC]	24	
	Input current	[mA]	4 (at 24 V DC)	
	Duty cycle	[ms]	min. 20	
	Signal voltage	[V DC]	0 ... 5 (for logic 0) 5 ... 30 (for logic 1)	
Digital outputs (short circuit proof)	Output voltage		min. V_b ... V_b : -3 V DC (at 0.5 A)	
	Output current	[A]	max. 0.1	
	Total output current	[A]	max. 0.5	
Linear potentiometer input	Operating voltage	[V DC]	+10	-
	Input voltage	[V DC]	0 ... +10	-
MTS Temposonic input	Operating voltage	[V DC]	-	24
	Communication		-	CAN fieldbus (1 Mbaud)
Valve output	Operating voltage	[V DC]	24	
	Output voltage	[V DC]	0 ... +10	
Relative air humidity	[%]	95 (non-condensing)		
Weight	[g]	approx. 400		

Operating and environmental conditions				
End position controller	Type	SPC11-POT-TLF	SPC11-POT-LWG	SPC11-MTS-AIF
Temperature range	[°C]	0 ... +50		
Protection class to DIN 40 050		IP65		
Vibration resistance		Tested to DIN/IEC 68 Part 2 – 6, severity 1		
Shock resistance		Tested to DIN/IEC 68 Part 2 – 27, severity 2		
Electromagnetic compatibility	Interference emission	Tested to EN 55 011, limit value class B		
	Interference sensitivity	Tested to EN 50 082-2		
CE symbol		To EMC Directive 89/336/EEC		

End position controllers SPC11

Technical data

Dimensions

Download CAD data → www.festo.com/en/engineering

SPC11-...

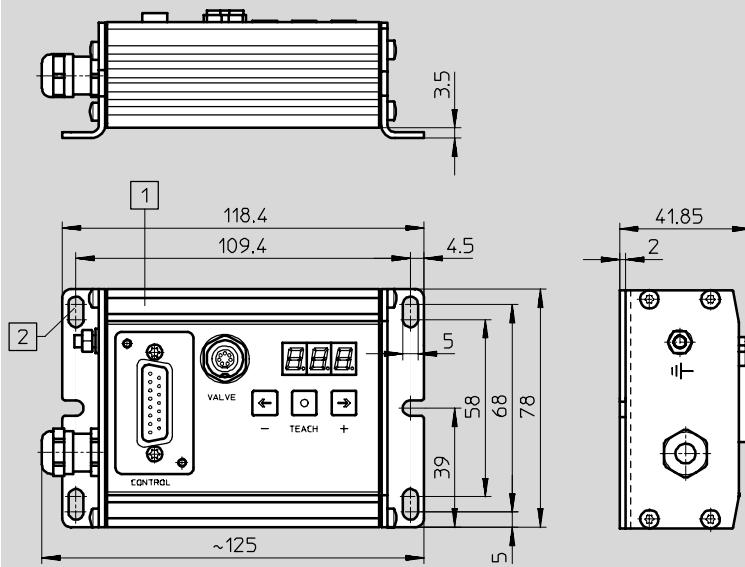

- 1 Slot for inscription labels:
18182 IBS-9x20
18576 IBS-6x10
- 2 Mounting options for M4 screws

Ordering data

Designation	Part No.	Type
For analogue displacement encoder MLO-POT-...-TLF	192 216	SPC11-POT-TLF
For analogue displacement encoder MLO-POT-...-LWG	192 217	SPC11-POT-LWG
For digital displacement encoder MME-MTS-...-AIF	192 218	SPC11-MTS-AIF

End position controllers SPC11

Technical data

FESTO

Teach-in function

SPC11-POT-TLF-ASI
SPC11-POT-LWG-ASI
SPC11-MTS-AIF-ASI

The teach-in travel to determine the system data and end positions can be started by means of a button on the end position controller SPC11 or via the AS-i interface.

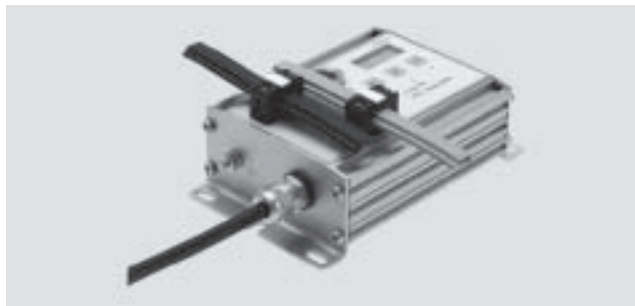

General technical data				
End position controller	Type	SPC11-POT-TLF-ASI	SPC11-POT-LWG-ASI	SPC11-MTS-AIF-ASI
Operating voltage	[V DC]	24 (-25 ... +25%)		
Current consumption	with valve	[A]	1.3	
	without valve	[mA]	70	170
Residual ripple	[%]	max. 6		
AS-interface	Operating voltage	[V DC]	26.5 ... 31.6	
	Input current	[mA]	40	
Linear potentiometer input	Operating voltage	[V DC]	+10	-
	Input voltage	[V DC]	0 ... +10	-
MTS Temposonic input	Operating voltage	[V DC]	-	24
	Communication		-	CAN fieldbus (1 Mbaud)
Valve output	Operating voltage	[V DC]	24	
	Output voltage	[V DC]	0 ... +10	
Relative air humidity	[%]	95 (non-condensing)		
Weight	[g]	approx. 400		

Operating and environmental conditions				
End position controller	Type	SPC11-POT-TLF-ASI	SPC11-POT-LWG-ASI	SPC11-MTS-AIF-ASI
Temperature range	[°C]	0 ... +50		
Protection class to DIN 40 050		IP65		
Vibration resistance		Tested to DIN/IEC 68 Part 2 – 6, severity 1		
Shock resistance		Tested to DIN/IEC 68 Part 2 – 27, severity 2		
Electromagnetic compatibility	Interference emission	Tested to EN 55 011, limit value class B		
	Interference sensitivity	Tested to EN 50 082-2		
CE symbol		To EMC Directive 89/336/EEC		

End position controllers SPC11

Technical data

Dimensions

Download CAD data → www.festo.com/en/engineering

SPC11-...-ASI

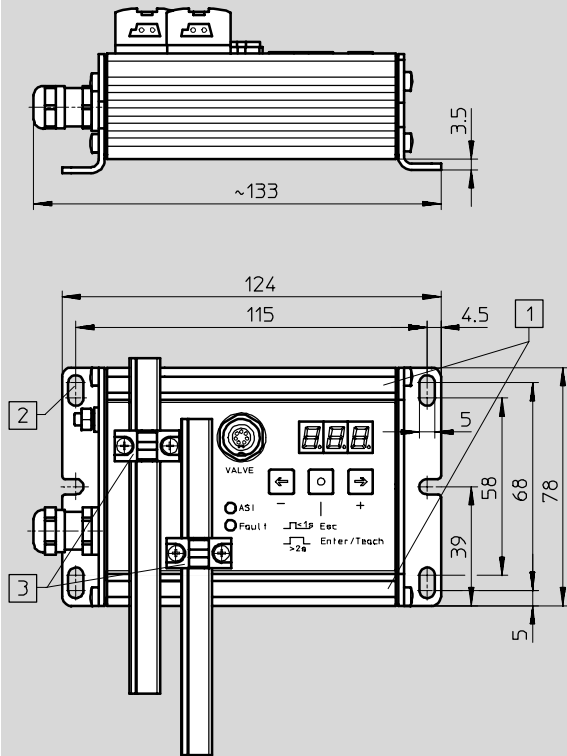

- 1 Slot for inscription labels:
18182 IBS-9x20
18576 IBS-6x10
- 2 Mounting options for M4 screws
- 3 Cable socket for AS-interface flat cable:
18785 ASI-SD-FK
(not included in scope of delivery for SPC11-...-ASI)

Ordering data

Designation	Part No.	Type
For analogue displacement encoder MLO-POT-...-TLF	526 907	SPC11-POT-TLF-ASI
For analogue displacement encoder MLO-POT-...-LWG	526 908	SPC11-POT-LWG-ASI
For digital displacement encoder MME-MTS-...-AIF	526 909	SPC11-MTS-AIF-ASI

End position controllers SPC11

Technical data

Ordering example

For pneumatic linear drives DGP/DGPL, DGPI/DGPIL

A workpiece weighing 3 kg is to be moved horizontally on a loading station. A workpiece gripper attached

to the slide of the linear drive weighs 14 kg. The total weight to be moved is therefore 17 kg. The desired travel

distance is 1000 mm. The travel time is to be < 1.5 seconds.

Step 1:

Selecting the nominal stroke

For a travel distance of 1000 mm, use the table on → 5 / 1.4-17 to select the next-largest effective stroke of 1185 mm (max. nominal stroke 1250 mm). This column has a grey background.



Note

Quote the nominal cylinder stroke in your order!

Step 2:

Specifying the drive

For a total weight of 17 kg to be moved horizontally, there is a choice of piston diameters of 25, 32, 40, 50 and 63 mm (see data for max. total weight to be moved).

For the purposes of our example, the drive DGPL-32-1250-PPV-A-B-KF-GK-...-D2, Part No. 175 135 has been selected.

Step 3:

Specifying the displacement encoder

The appropriate length of the displacement encoder is governed by the nominal cylinder stroke.

The column with the grey background in the “Displacement encoder” section of the table shows Part No. 152 633 (analogue encoder) which is selected for this example. As an alternative the digital measuring system MME-MTS-...-AIF may be used.



Selection and ordering aid for Soft Stop and ProDrive
www.festo.com/en/engineering or the Pneumatics Catalogue on CD-ROM



Note

Remember when selecting the drive mounting components that some of these are not backlash-free and therefore cannot be used with the Soft Stop system. The drives must be mounted directly.



Note

Check that the loads placed on the drive by a gripper during the movement process do not exceed permissible limits. To carry out simulation quickly and easily, use the Soft Stop software tool and ProDrive.

Step 4:

Specifying a proportional 5/3-way valve

The appropriate proportional 5/3-way valve is shown at the intersection of the grey column used in step 1 and the line for the selected linear drive DGPL-32-... in the “Proportional 5/3-way valve” section of the table. In the case of our example, this is the proportional 5/3-way valve MPYE-5-1/4-010B with the Part No. 151 694.

Step 5:

Completing the order information

To order a complete system you must add the data for the end position controller, valve and controller cables and manual (if required). The complete ordering data for our example can be found on → 5 / 1.4-17. A manual should normally be ordered. If you already have one, leave the appropriate box blank, indicating an express waiver of a manual.

Step 6:

Determining the travel time

To calculate the travel time use the “Soft Stop” software tool. The travel time for the ordering example is 1.10 seconds.



Note

For vertical travel, t_{up} and t_{down} are the two different travel times.

Ordering data

Pneumatic linear drive		Displacement encoder		Proportional 5/3-way valve		End position controller	
Part No.	Type	Part No.	Type	Part No.	Type	Part No.	Type
175 135	DGPL-32-1250-PPV-A-B-KF-GK-...-D2	152 633	MLO-POT-1250-TLF	151 694	MPYE-5-1/4-010B	192 216	SPC11-POT-TLF
Valve cable		Controller cable		Manual			
Part No.	Type	Part No.	Type	Part No.	Type		
170 238	KMPYE-AIF-1-GS-GD-2	177 674	KMPV-SUB-D-15-10	196 723	P.BE-SPC11-SYS-DE		
				196 729	P.BE-SPC11-DGP-DE		

End position controllers SPC11

Technical data

FESTO

Step 1 and 2:													
Pneumatic linear drives/Type		DGP-... ¹⁾ ... ³⁾ -PPV-A-B-D2					DGPI-... ²⁾ ... ³⁾ -PPV-A-B-D2						
		DGPL-... ¹⁾ ... ³⁾ -PPV-A-KF-B-GK-...-D2					DGPIL-... ²⁾ ... ³⁾ -PPV-A-B-KF-...-D2						
Effective stroke	[mm]	160	235	295	385	435	535	685	935	1185	1435	1685	1935
Nominal stroke	[mm]	225	300	360	450	500	600	750	1000	1250	1500	1750	2000
Max. overall mass to be moved horizontally/ vertically by ∅	25 mm	30/10 kg											
	32 mm	45/15 kg											
	40 mm	70/25 kg											
	50 mm	120/40 kg											
Part No. for ∅	25 mm	175 134											
	32 mm	175 135											
	40 mm	175 136											
	50 mm	175 137											
	63 mm	175 138											

Step 3:													
Displacement encoder ⁵⁾		MLO-POT-...-TLF MME-MTS-...-AIF											
Nominal stroke	[mm]	225	300	360	450	500	600	750	1000	1250	1500	1750	2000
Encoder length	[mm]	225	300	360	450	500	600	750	1000	1250	1500	1750	2000
Part No.	MLO-POT-...-TLF	152625	152626	152627	152628	152629	152630	152631	152632	152633	152634	152635	152636
	MME-MTS-...-AIF	178310	178309	178308	178307	178306	178305	178304	178303	178302	178301	178300	178299

Step 4:													
Proportional 5/3-way valves ⁶⁾		1 = 151 692 MPYE-5-1/8-LF-010-B					3 = 151 694 MPYE-5-1/4-010-B						
Part No./Type		2 = 151 693 MPYE-5-1/8-HF-010-B					4 = 151 695 MPYE-5-3/8-010-B						
Horizontal/vertical for ∅	25 mm	1 ⁴⁾	1/1	2/1	2/1	2/1	2/2	2/2	2/3	2/3	2/3	2/3	2/3
	32 mm	1 ⁴⁾	2/1	2/1	2/1	2/1	2/1	3/2	3/3	3/3	3/3	3/3	3/3
	40 mm	2/1	2/1	2/1	2/1	2/2	3/3	3/4	3/4	3/4	3/4	3/4	3/4
	50 mm	1/1	2/1	2/2	3/2	3/3	4/3	4/4	4/4	4/4	4/4	4/4	4/4
	63 mm	2/1	2/2	3/3	3/3	4/4	4/4	4/4	4/4	4/4	4/4	4/4	4/4

Step 5:				
End position controllers and accessories		Part No.	Type	Brief description
End position controller	SPC11	192 216	SPC11-POT-TLF	
		192 218	SPC11-MTS-AIF	
	SPC11-ASI	526 907	SPC11-POT-TLF-ASI	
		526 909	SPC11-MTS-AIF-ASI	
Cable	Valve	170 238	KMPYE-AIF-1-GS-GD-2	Cable length 2 m
		170 239	KMPYE-AIF-1-GS-GD-0,3	Cable length 0.3 m
	SPC11/PLC	177 673	KMPV-SUB-D-15-5	Cable length 5 m
		177 674	KMPV-SUB-D-15-10	Cable length 10 m
	SPC11-ASI/ PLC	18 940	KASI-1,5-Y-100	For logic voltage, cable length 100 m (yellow)
		18 941	KASI-1,5-Z-100	For load voltage, cable length 100 m (black)

 **Note**
Manuals → 5 / 1.4-37

- 1) Indicate piston ∅. Technical data and dimensions → 5 / 1.1-20.
- 2) Indicate piston ∅. Technical data and dimensions → 5 / 1.1-38.
- 3) Indicate calculated nominal stroke of cylinder.
- 4) Upon request.
- 5) Technical data and dimensions → 5 / 1.2-2.
(not needed for DGPI/DGPIL, has integrated displacement encoder).
- 6) Technical data and dimensions → 5 / 1.5-1.

End position controllers SPC11

Technical data

Accessories for the package solution for DGP/DGPL, DGPI/DGPIL horizontally mounted

For nominal strokes 225 ... 2000 mm

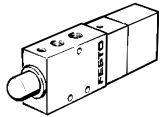
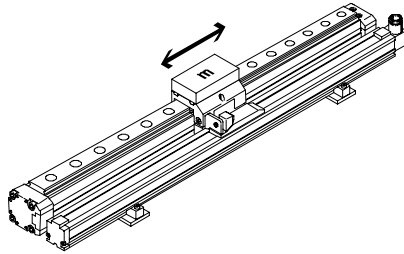

Ordering data

Nominal stroke DGP/L, DGPI/L-... [mm]	Proportional 5/3-way valve Type	Fittings ¹⁾				Compressed air tubing		Silencer ²⁾	
		for MPYE-5-...		DGP/L, DGPI/L		Part No.	Type	Part No.	Type
Ø 25 mm									
225 ... 300	MPYE-5-1/8-LF-010-B	153 004	QS-1/8-8	153 004	QS-1/8-8	152 587	PUN-8x1,25	2307	U-1/8
360 ... 2000	MPYE-5-1/8-HF-010-B								
Ø 32 mm									
225	MPYE-5-1/8-LF-010-B	153 004	QS-1/8-8	153 004	QS-1/8-8	152 587	PUN-8x1,25	2307	U-1/8
300 ... 600	MPYE-5-1/8-HF-010-B								
750 ... 2000	MPYE-5-1/4-010-B	153 005	QS-1/4-8	153 004	QS-1/8-8	152 587	PUN-8x1,25	2316	U-1/4
Ø 40 mm									
225 ... 500	MPYE-5-1/8-HF-010-B	153 004	QS-1/8-8	153 005	QS-1/4-8	152 587	PUN-8x1,25	2307	U-1/8
600 ... 2000	MPYE-5-1/4-010-B	153 007	QS-1/4-10	153 007	QS-1/4-10	152 588	PUN-10x1,5	2316	U-1/4
Ø 50 mm									
225	MPYE-5-1/8-LF-010-B	153 004	QS-1/8-8	153 005	QS-1/4-8	152 587	PUN-8x1,25	2307	U-1/8
300 ... 360	MPYE-5-1/8-HF-010-B								
450 ... 500	MPYE-5-1/4-010-B	153 007	QS-1/4-10	153 007	QS-1/4-10	152 588	PUN-10x1,5	2316	U-1/4
600 ... 2000	MPYE-5-3/8-010-B	153 008	QS-3/8-10					2309	U-3/8
Ø 63 mm									
225 ... 300	MPYE-5-1/8-HF-010-B	153 004	QS-1/8-8	153 006	QS-3/8-8	152 587	PUN-8x1,25	2307	U-1/8
360 ... 450	MPYE-5-1/4-010-B	153 007	QS-1/4-10	153 008	QS-3/8-10	152 588	PUN-10x1,5	2316	U-1/4
500 ... 2000	MPYE-5-3/8-010-B	153 009	QS-3/8-12	153 009	QS-3/8-12	152 589	PUN-12x2	2309	U-3/8

1) Fittings sold only in packs of 10.

2) 2 pieces are required.

End position controllers SPC11

Technical data

Accessories for the package solution for DGP/DGPL, DGPI/DGPIL horizontally mounted

For nominal strokes 225 ... 2000 mm

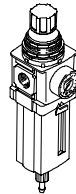
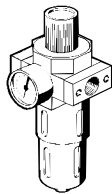

Ordering data										
Nominal stroke DGP/L, DGPI/L-... [mm]	Filter regulator, D series with filter cartridge 5 µm			Filter cartridge 5 µm D series		Filter regulator, MS series with filter cartridge 5 µm			Filter cartridge 5 µm MS series	
	Part No.	Type		Part No.	Type	Part No.	Type		Part No.	Type
Ø 25 mm										
225 ... 2000	162 719	LFR-¼-D-5M-MINI		159 640	LFP-D-MINI-5M		529 152	MS-LFR-¼-D7-CRM-AS		534 501 MS4-LFP-C
Ø 32 mm										
225 ... 600	162 719	LFR-¼-D-5M-MINI		159 640	LFP-D-MINI-5M		529 152	MS-LFR-¼-D7-CRM-AS		534 501 MS4-LFP-C
750 ... 2000	162 721	LFR-⅜-D-5M-MIDI		159 594	LFP-D-MIDI-5M		529 204	MS6-LFR-¼-D7-CRM-AS		534 499 MS6-LFP-C
Ø 40 mm										
225 ... 500	162 719	LFR-¼-D-5M-MINI		159 640	LFP-D-MINI-5M		529 152	MS-LFR-¼-D7-CRM-AS		534 501 MS4-LFP-C
600 ... 2000	162 721	LFR-⅜-D-5M-MIDI		159 594	LFP-D-MIDI-5M		529 204	MS6-LFR-¼-D7-CRM-AS		534 499 MS6-LFP-C
Ø 50 mm										
225 ... 360	162 719	LFR-¼-D-5M-MINI		159 640	LFP-D-MINI-5M		529 152	MS-LFR-¼-D7-CRM-AS		534 501 MS4-LFP-C
450 ... 500	162 721	LFR-⅜-D-5M-MIDI		159 594	LFP-D-MIDI-5M		529 204	MS6-LFR-¼-D7-CRM-AS		534 499 MS6-LFP-C
600 ... 2000	162 724	LFR-¾-D-5M-MAXI		159 641	LFP-D-MAXI-5M		529 224	MS6-LFR-⅜-D7-CRM-AS		534 499 MS6-LFP-C
Ø 63 mm										
225 ... 300	162 719	LFR-¼-D-5M-MINI		159 640	LFP-D-MINI-5M		529 152	MS-LFR-¼-D7-CRM-AS		534 501 MS4-LFP-C
360 ... 450	162 721	LFR-⅜-D-5M-MIDI		159 594	LFP-D-MIDI-5M		529 204	MS6-LFR-¼-D7-CRM-AS		534 499 MS6-LFP-C
500 ... 2000	162 724	LFR-¾-D-5M-MAXI		159 641	LFP-D-MAXI-5M		529 224	MS6-LFR-⅜-D7-CRM-AS		534 499 MS6-LFP-C

End position controllers SPC11

Technical data

Accessories for the package solution for DGP/DGPL, DGPI/DGPIL vertically mounted

For nominal strokes 225 ... 2000 mm

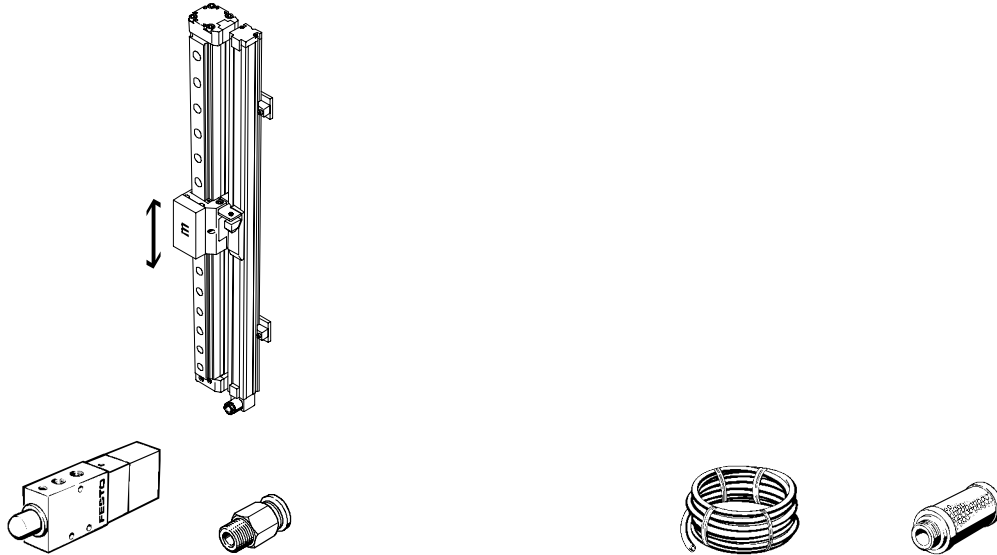

Ordering data									
Nominal stroke DGP/L, DGPI/L [mm]	Proportional 5/3-way valve Type	Fittings ¹⁾				Compressed air tubing		Silencer ²⁾	
		for MPYE-5-...		DGP/L, DGPI/L		Part No.	Type	Part No.	Type
		Part No.	Type	Part No.	Type			Part No.	Type
Ø 25 mm									
300 ... 500	MPYE-5-1/8-LF-010-B	153 004	QS-1/8-8	153 004	QS-1/8-8	152 587	PUN-8x1,25	2307	U-1/8
600 ... 750	MPYE-5-1/8-HF-010-B								
1000 ... 2000	MPYE-5-1/4-010-B	153 005	QS-1/4-8					2316	U-1/4
Ø 32 mm									
300 ... 600	MPYE-5-1/8-LF-010-B	153 004	QS-1/8-8	153 004	QS-1/8-8	152 587	PUN-8x1,25	2307	U-1/8
750	MPYE-5-1/8-HF-010-B								
1000 ... 2000	MPYE-5-1/4-010-B	153 005	QS-1/4-8					2316	U-1/4
Ø 40 mm									
225 ... 450	MPYE-5-1/8-LF-010-B	153 004	QS-1/8-8	153 004	QS-1/8-8	152 587	PUN-8x1,25	2307	U-1/8
500	MPYE-5-1/8-HF-010-B			153 005	QS-1/4-8				
600	MPYE-5-1/4-010-B	153 007	QS-1/4-10	153 007	QS-1/4-10	152 588	PUN-10x1,5	2316	U-1/4
750 ... 2000	MPYE-5-3/8-010-B	153 008	QS-3/8-10					2309	U-3/8
Ø 50 mm									
225 ... 300	MPYE-5-1/8-LF-010-B	153 004	QS-1/8-8	153 005	QS-1/4-8	152 587	PUN-8x1,25	2307	U-1/8
360 ... 450	MPYE-5-1/8-HF-010-B								
500 ... 600	MPYE-5-1/4-010-B	153 007	QS-1/4-10	153 007	QS-1/4-10	152 588	PUN-10x1,5	2316	U-1/4
750 ... 2000	MPYE-5-3/8-010-B	153 008	QS-3/8-10					2309	U-3/8
Ø 63 mm									
225	MPYE-5-1/8-LF-010-B	153 004	QS-1/8-8	153 006	QS-3/8-8	152 587	PUN-8x1,25	2307	U-1/8
300	MPYE-5-1/8-HF-010-B								
360 ... 450	MPYE-5-1/4-010-B	153 007	QS-1/4-10	153 008	QS-3/8-10	152 588	PUN-10x1,5	2316	U-1/4
500 ... 2000	MPYE-5-3/8-010-B	153 009	QS-3/8-12	153 009	QS-3/8-12	152 589	PUN-12x2	2309	U-3/8

1) Fittings sold only in packs of 10.

2) 2 pieces are required.

End position controllers SPC11

Technical data

Accessories for the package solution for DGP/DGPL, DGPI/DGPIL vertically mounted

For nominal strokes 225 ... 2000 mm

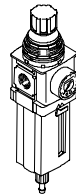
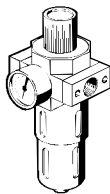

Ordering data										
Nominal stroke DGP/L, DGPL/L [mm]	Filter regulator, D series with filter cartridge 5 µm			Filter cartridge 5 µm D series		Filter regulator, MS series with filter cartridge 5 µm			Filter cartridge 5 µm MS series	
	Part No.	Type		Part No.	Type	Part No.	Type		Part No.	Type
Ø 25 mm										
300 ... 750	162 719	LFR-1/4-D-5M-MINI		159 640	LFP-D-MINI-5M		529 152	MS4-LFR-1/4-D7-CRM-AS	534 501	MS4-LFP-C
1000 ... 2000	162 721	LFR-3/8-D-5M-MIDI		159 594	LFP-D-MIDI-5M		529 204	MS6-LFR-1/4-D7-CRM-AS	534 499	MS6-LFP-C
Ø 32 mm										
300 ... 750	162 719	LFR-1/4-D-5M-MINI		159 640	LFP-D-MINI-5M		529 152	MS4-LFR-1/4-D7-CRM-AS	534 501	MS4-LFP-C
1000 ... 2000	162 721	LFR-3/8-D-5M-MIDI		159 594	LFP-D-MIDI-5M		529 204	MS6-LFR-1/4-D7-CRM-AS	534 499	MS6-LFP-C
Ø 40 mm										
225 ... 500	162 719	LFR-1/4-D-5M-MINI		159 640	LFP-D-MINI-5M		529 152	MS4-LFR-1/4-D7-CRM-AS	534 501	MS4-LFP-C
600	162 721	LFR-3/8-D-5M-MIDI		159 594	LFP-D-MIDI-5M		529 204	MS6-LFR-1/4-D7-CRM-AS	534 499	MS6-LFP-C
750 ... 2000	162 724	LFR-3/4-D-5M-MAXI		159 641	LFP-D-MAXI-5M		529 224	MS6-LFR-3/8-D7-CRM-AS		
Ø 50 mm										
225 ... 300	162 719	LFR-1/4-D-5M-MINI		159 640	LFP-D-MINI-5M		529 152	MS4-LFR-1/4-D7-CRM-AS	534 501	MS4-LFP-C
360 ... 600	162 721	LFR-3/8-D-5M-MIDI		159 594	LFP-D-MIDI-5M		529 204	MS6-LFR-1/4-D7-CRM-AS	534 499	MS6-LFP-C
750 ... 2000	162 724	LFR-3/4-D-5M-MAXI		159 641	LFP-D-MAXI-5M		529 224	MS6-LFR-3/8-D7-CRM-AS		
Ø 63 mm										
225 ... 300	162 719	LFR-1/4-D-5M-MINI		159 640	LFP-D-MINI-5M		529 152	MS4-LFR-1/4-D7-CRM-AS	534 501	MS4-LFP-C
360 ... 450	162 721	LFR-3/8-D-5M-MIDI		159 594	LFP-D-MIDI-5M		529 204	MS6-LFR-1/4-D7-CRM-AS	534 499	MS6-LFP-C
500 ... 2000	162 724	LFR-3/4-D-5M-MAXI		159 641	LFP-D-MAXI-5M		529 224	MS6-LFR-3/8-D7-CRM-AS		

End position controllers SPC11

Technical data

Ordering example

For the pneumatic drive DNC with displacement encoder LWG

A workpiece weighing 55 kg is to be moved horizontally on a loading station. The workpiece gripper

attached to the piston rod of the drive weighs 40 kg. The total weight to be moved is therefore 95 kg. The desired

travel distance is 300 mm. The travel time is to be < 1.5 seconds.



Selection and ordering aid for Soft Stop and ProDrive
www.festo.com/en/engineering
or the Pneumatics Catalogue on CD-ROM

Step 1: Selecting the nominal stroke

For a travel distance of 300 mm, use the table on → 5 / 1.4-23 to select the next-largest standard stroke of 320 mm or the nominal stroke of 291 ... 350 mm. This column has a grey background.

Step 2: Specifying the drive

For a total weight of 95 kg to be moved horizontally, there is a choice of piston diameters of 50, 63 and 80 mm (see data for max. total weight to be moved).
For the purposes of our example, the drive DNC-50-320-PPV-A, Part No. 163 378 has been selected.

Step 3: Specifying the displacement encoder

The appropriate length of the displacement encoder is governed by the nominal cylinder stroke. The column with the grey background in the "Displacement encoder" section of the table shows Part No. 152 647 for this example.



Note

Remember when selecting the drive mounting components that some of these are not backlash-free and therefore cannot be used with the Soft Stop system. The drives must be mounted directly.



Note

Quote the nominal cylinder stroke in your order!



Note

The displacement encoder is supplied separately and must be mounted by the user.



Note

Check that the loads placed on the drive by a gripper during the movement process do not exceed permissible limits.
To carry out simulation quickly and easily, use the Soft Stop software tool.

Step 4: Specifying a proportional 5/3-way valve

The appropriate proportional 5/3-way valve is shown at the intersection of the grey column used in step 1 and the line for the selected linear drive DNC-50-... in the "Proportional 5/3-way valve" section of the table. In the case of our example, this is the proportional 5/3-way valve MPYE-5-1/8- HF-010B with the Part No. 151 693.

Step 5: Completing the order information

To order a complete system you must add the data for the end position controller, valve and controller cables and manual (if required). The complete ordering data for our example can be found on → 5 / 1.4-23. A manual should normally be ordered. If you already have one, leave the appropriate box blank, indicating an express waiver of a manual.

Step 6: Determining the travel time

To calculate the travel time use the "Soft Stop" software tool. The travel time for the ordering example is 0.96 seconds.

Ordering data							
Pneumatic drive		Displacement encoder		Proportional 5/3-way valve		End position controller	
Part No.	Type	Part No.	Type	Part No.	Type	Part No.	Type
163 378	DNC-50-320-PPV-A	152 647	MLO-POT-360-LWG	151 693	MPYE-5-1/8-HF-010B	192 217	SPC11-POT-LWG
Valve cable		Controller cable		Manual			
Part No.	Type	Part No.	Type	Part No.	Type		
170 238	KMPYE-AIF-1-GS-GD-2	177 674	KMPV-SUB-D-15-10	196 723	P.BE-SPC11-SYS-DE		
				196 735	P.BE-SPC11-DNC-DE		

End position controllers SPC11

Technical data

Step 1 and 2:											
Standard cylinders/Type		DNC-... ¹⁾ ... ²⁾ -PPV-A									
Effective stroke	[mm]	80 – 90	91 – 115	116 – 140	141 – 175	176 – 215	216 – 290	291 – 350	351 – 440	441 – 590	591 – 735
Nominal stroke (standard stroke)	[mm]	80	100	125	160	200	250	320	400	500	650
Max. overall mass to be moved horizontally by \varnothing	32 mm	45 kg									
	40 mm	75 kg									
	50 mm	120 kg									
	63 mm	180 kg									
Part No. for \varnothing	32 mm	163 308	163 309	163 310	163 311	163 312	163 313	163 314	163 315	163 316	163 304
	40 mm	163 340	163 341	163 342	163 343	163 344	163 345	163 346	163 347	163 348	163 336
	50 mm	163 372	163 373	163 374	163 375	163 376	163 377	163 378	163 379	163 380	163 368
	63 mm	163 404	163 405	163 406	163 407	163 408	163 409	163 410	163 411	163 412	163 400
	80 mm	163 436	163 437	163 438	163 439	163 440	163 441	163 442	163 443	163 444	163 432

Step 3:											
Displacement encoder ³⁾		MLO-POT-...-LWG									
Nominal stroke	[mm]	80 – 90	91 – 115	116 – 140	141 – 175	176 – 215	216 – 290	291 – 350	351 – 440	441 – 590	591 – 735
Encoder length	[mm]	100	150	150	225	225	300	360	450	600	750
Part No.		192 213	192 214	192 214	152 645	152 645	152 646	152 647	152 648	152 650	152 651

Step 4:											
Proportional 5/3-way valves ⁴⁾		1 = 151 692 MPYE-5-1/8-LF-010-B					3 = 151 694 MPYE-5-1/4-010-B				
Part No./Type		2 = 151 693 MPYE-5-1/8-HF-010-B					4 = 151 695 MPYE-5-3/8-010-B				
Horizontal for \varnothing	32 mm	1	1	1	1	1	1	1	1	2	2
	40 mm	1	1	1	1	1	1	2	2	3	3
	50 mm	1	1	1	1	1	1	2	2	3	3
	63 mm	1	1	1	1	2	2	2	3	3	4
	80 mm	1	1	2	2	3	3	3	3	4	4

Step 5:			
End position controllers and accessories	Part No.	Type	Brief description
End position controller	SPC11	192 217 SPC11-POT-LWG	
	SPC11-ASI	526 908 SPC11-POT-LWG-ASI	
Cable	Valve	170 238 KMPYE-AIF-1-GS-GD-2	Cable length 2 m
		170 239 KMPYE-AIF-1-GS-GD-0,3	Cable length 0.3 m
	SPC11/PLC	177 673 KMPV-SUB-D-15-5	Cable length 5 m
		177 674 KMPV-SUB-D-15-10	Cable length 10 m
SPC11-ASI/ PLC	18 940 KASI-1,5-Y-100	For logic voltage, cable length 100 m (yellow)	
	18 941 KASI-1,5-Z-100	For load voltage, cable length 100 m (black)	

 **Note**
Manuals → 5 / 1.4-37

- 1) Indicate piston \varnothing . Technical data and dimensions → Volume 1.
- 2) Indicate calculated nominal stroke of cylinder.
- 3) Technical data and dimensions → 5 / 1.2-2.
- 4) Technical data and dimensions → 5 / 1.5-1.

End position controllers SPC11

Technical data

FESTO

Accessories for the package solution for DNC horizontally mounted

For nominal strokes 80 ... 735 mm

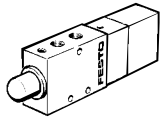
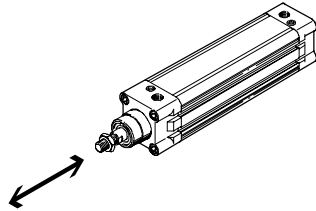

Ordering data

Nominal stroke DNC-... [mm]	Proportional 5/3-way valve Type	Fittings ¹⁾				Compressed air tubing		Silencer ²⁾	
		for MPYE-5-...		DNC		Part No.	Type	Part No.	Type
Ø 32 mm									
80 ... 440	MPYE-5-1/8-LF-010-B	153 004	QS-1/8-8	153 004	QS-1/8-8	152 587	PUN-8x1,25	2307	U-1/8
441 ... 735	MPYE-5-1/8-HF-010-B								
Ø 40 mm									
80 ... 290	MPYE-5-1/8-LF-010-B	153 004	QS-1/8-8	153 004	QS-1/8-8	152 587	PUN-8x1,25	2307	U-1/8
291 ... 440	MPYE-5-1/8-HF-010-B			153 005	QS-1/4-8				
441 ... 735	MPYE-5-1/4-010-B	153 007	QS-1/4-10	153 007	QS-1/4-10	152 588	PUN-10x1,5	2316	U-1/4
Ø 50 mm									
80 ... 290	MPYE-5-1/8-LF-010-B	153 004	QS-1/8-8	153 005	QS-1/4-8	152 587	PUN-8x1,25	2307	U-1/8
291 ... 440	MPYE-5-1/8-HF-010-B								
441 ... 735	MPYE-5-1/4-010-B	153 007	QS-1/4-10	153 007	QS-1/4-10	152 588	PUN-10x1,5	2316	U-1/4
Ø 63 mm									
80 ... 175	MPYE-5-1/8-LF-010-B	153 004	QS-1/8-8	153 004	QS-1/8-8	152 587	PUN-8x1,25	2307	U-1/8
176 ... 350	MPYE-5-1/8-HF-010-B			153 006	QS-3/8-8				
351 ... 590	MPYE-5-1/4-010-B	153 007	QS-1/4-10	153 008	QS-3/8-10	152 588	PUN-10x1,5	2316	U-1/4
591 ... 735	MPYE-5-3/8-010-B	153 009	QS-3/8-12	153 009	QS-3/8-12	152 589	PUN-12x2	2309	U-3/8
Ø 80 mm									
80 ... 115	MPYE-5-1/8-LF-010-B	153 004	QS-1/8-8	153 004	QS-1/8-8	152 587	PUN-8x1,25	2307	U-1/8
116 ... 175	MPYE-5-1/8-HF-010-B			153 006	QS-3/8-8				
176 ... 440	MPYE-5-1/4-010-B	153 007	QS-1/4-10	153 008	QS-3/8-10	152 588	PUN-10x1,5	2316	U-1/4
441 ... 735	MPYE-5-3/8-010-B	153 009	QS-3/8-12	153 009	QS-3/8-12	152 589	PUN-12x2	2309	U-3/8

1) Fittings sold only in packs of 10.

2) 2 pieces are required.

End position controllers SPC11

Technical data

Accessories for the package solution for DNC horizontally mounted

For nominal strokes 80 ... 735 mm

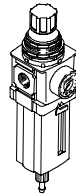
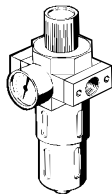

Ordering data								
Nominal stroke DNC-... [mm]	Filter regulator, D series with filter cartridge 5 µm		Filter cartridge 5 µm D series		Filter regulator, MS series with filter cartridge 5 µm		Filter cartridge 5 µm MS series	
	Part No.	Type	Part No.	Type	Part No.	Type	Part No.	Type
Ø 32 mm								
80 ... 735	162 719	LFR-1/4-D-5M-MINI	159 640	LFP-D-MINI-5M	529 152	MS4-LFR-1/4-D7-CRM-AS	534 501	MS4-LFP-C
Ø 40 mm								
80 ... 440	162 719	LFR-1/4-D-5M-MINI	159 640	LFP-D-MINI-5M	529 152	MS4-LFR-1/4-D7-CRM-AS	534 501	MS4-LFP-C
441 ... 735	162 721	LFR-3/8-D-5M-MIDI	159 594	LFP-D-MIDI-5M	529 204	MS6-LFR-1/4-D7-CRM-AS	534 499	MS6-LFP-C
Ø 50 mm								
80 ... 440	162 719	LFR-1/4-D-5M-MINI	159 640	LFP-D-MINI-5M	529 152	MS4-LFR-1/4-D7-CRM-AS	534 501	MS4-LFP-C
441 ... 735	162 721	LFR-3/8-D-5M-MIDI	159 594	LFP-D-MIDI-5M	529 204	MS6-LFR-1/4-D7-CRM-AS	534 499	MS6-LFP-C
Ø 63 mm								
80 ... 350	162 719	LFR-1/4-D-5M-MINI	159 640	LFP-D-MINI-5M	529 152	MS4-LFR-1/4-D7-CRM-AS	534 501	MS4-LFP-C
351 ... 590	162 721	LFR-3/8-D-5M-MIDI	159 594	LFP-D-MIDI-5M	529 204	MS6-LFR-1/4-D7-CRM-AS	534 499	MS6-LFP-C
591 ... 735	162 724	LFR-3/4-D-5M-MAXI	159 641	LFP-D-MAXI-5M	529 224	MS6-LFR-3/8-D7-CRM-AS	534 499	MS6-LFP-C
Ø 80 mm								
80 ... 175	162 719	LFR-1/4-D-5M-MINI	159 640	LFP-D-MINI-5M	529 152	MS4-LFR-1/4-D7-CRM-AS	534 501	MS4-LFP-C
176 ... 440	162 721	LFR-3/8-D-5M-MIDI	159 594	LFP-D-MIDI-5M	529 204	MS6-LFR-1/4-D7-CRM-AS	534 499	MS6-LFP-C
441 ... 735	162 724	LFR-3/4-D-5M-MAXI	159 641	LFP-D-MAXI-5M	529 224	MS6-LFR-3/8-D7-CRM-AS	534 499	MS6-LFP-C

End position controllers SPC11

Technical data

Ordering example

For the pneumatic drive DNCM with adapted displacement encoder LWH

A workpiece weighing 20 kg is to be moved horizontally on a handling station. An external guide is used to

accurately position the workpiece gripper which weighs 15 kg. The total weight is therefore 35 kg. The desired

travel distance is 180 mm. The travel time is to be < 1.0 second.

Step 1: Selecting the nominal stroke

For a travel distance of 180 mm, use the table on → 5 / 1.4-27 to select the next-largest standard stroke of 200 mm. This column has a grey background.



Note

Quote the nominal cylinder stroke in your order!

Step 2: Specifying the drive

For a total weight of 35 kg to be moved horizontally, the piston diameter of 32 mm is selected. In the variant DNCM-...-FENG, the drive is equipped with a guide unit (with ball bearing guide) as well as the displacement encoder. The guide unit is mounted and tested at the factory. For the purposes of our example, the drive DNCM-32-200-P-POT2-FENG, Part No. 528 940 has been selected.

Step 3: Displacement encoder

The appropriate displacement encoder for the drive is mounted and tested at the factory.



Selection and ordering aid for Soft Stop and ProDrive
www.festo.com/en/engineering
or the Pneumatics Catalogue on CD-ROM



Note

Remember when selecting the drive mounting components that some of these are not backlash-free and therefore cannot be used with the Soft Stop system. The drives must be mounted directly.



Note

Check that the loads placed on the drive by a gripper during the movement process do not exceed permissible limits.

To carry out simulation quickly and easily, use the Soft Stop software tool.

Step 4: Specifying a proportional 5/3-way valve

The appropriate proportional 5/3-way valve is shown at the intersection of the grey column used in step 1 and the line for the selected linear drive DNCM-32-... in the "Proportional 5/3-way valve" section of the table. In the case of our example, this is the proportional 5/3-way valve MPYE-5-1/8-LF-010B with the Part No. 151 692.

Step 5: Completing the order information

To order a complete system you must add the data for the end position controller, valve and controller cables and manual (if required). The complete ordering data for our example can be found on → 5 / 1.4-27. A manual should normally be ordered. If you already have one, leave the appropriate box blank, indicating an express waiver of a manual.

Step 6: Determining the travel time

To calculate the travel time use the "Soft Stop" software tool. The travel time for the ordering example is 0.69 seconds.

Ordering data					
Pneumatic drive		Proportional 5/3-way valve		End position controller	
Part No.	Type	Part No.	Type	Part No.	Type
528 940	DNCM-32-200-P-POT2-FENG	151 692	MPYE-5-1/8-LF-010B	192 216	SPC11-POT-TLF
Valve cable		Controller cable		Manual	
Part No.	Type	Part No.	Type	Part No.	Type
170 238	KMPYE-AIF-1-GS-GD-2	177 674	KMPV-SUB-D-15-10	196 723	P.BE-SPC11-SYS-DE
				532 790	P.BE-SPC11-DNCM-DE

End position controllers SPC11

Technical data

Step 1:								
Standard cylinders/Type		DNCM-... ¹⁾ ... ²⁾ .p... ³⁾						
Nominal stroke (standard stroke)	[mm]	100	160	200	250	320	400	500
Max. overall mass to be moved horizontally/ vertically by \varnothing	32 mm	45/15 kg						
	50 mm	120/40 kg						
Part No. for \varnothing	32 mm	528 940						
	50 mm	528 941						

Step 2 and 3: → 5 / 1.4-29

Step 4:								
Proportional 5/3-way valves ⁴⁾		1 = 151 692 MPYE-5-1/8-LF-010-B			3 = 151 694 MPYE-5-1/4-010-B			
Part No./Type		2 = 151 693 MPYE-5-1/8-HF-010-B						
Horizontal/vertical for \varnothing	32 mm	1/1	1/1	1/1	1/1	2/1	2/1	2/1
	50 mm	1/1	1/1	1/1	2/1	2/1	2/2	3/3

Step 5:				
End position controllers and accessories		Part No.	Type	Brief description
End position controller	SPC11	192 216	SPC11-POT-TLF	
	SPC11-ASI	526 907	SPC11-POT-TLF-ASI	
Cable	Valve	170 238	KMPYE-AIF-1-GS-GD-2	Cable length 2 m
		170 239	KMPYE-AIF-1-GS-GD-0,3	Cable length 0.3 m
	SPC11/PLC	177 673	KMPV-SUB-D-15-5	Cable length 5 m
		177 674	KMPV-SUB-D-15-10	Cable length 10 m
	SPC11-ASI/PLC	18 940	KASI-1,5-Y-100	For logic voltage, cable length 100 m (yellow)
		18 941	KASI-1,5-Z-100	For load voltage, cable length 100 m (black)

 **Note**

Manuals → 5 / 1.4-37

- 1) Indicate piston \varnothing . Technical data and dimensions → 5 / 1.1-4.
- 2) Indicate calculated nominal stroke of cylinder.
- 3) Design as per DNCM product modules.
- 4) Technical data and dimensions → 5 / 1.5-1.

End position controllers SPC11

Technical data

FESTO

Arrangement of the displacement encoder

DNCM-...-POT1, encoder underneath

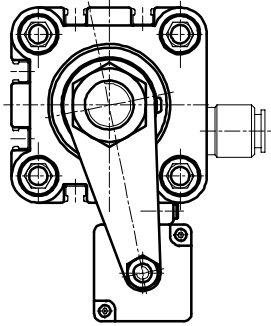

DNCM-...-POT2, encoder at side

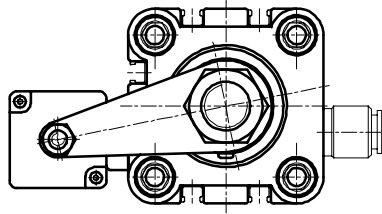

DNCM-...-POT3, encoder on top

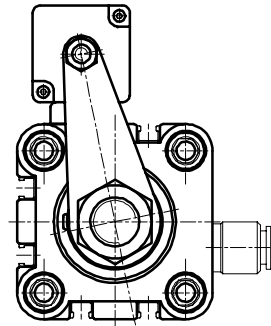

End position controllers SPC11

Ordering data – Modular products

Step 2 and 3:

M Mandatory data						O Options		
Module No.	Basic function	Size	Stroke	Cushioning	Encoder attachment position	Type of piston rod	Guide	Position sensing
528 940 528 941	DNCM	32 50	100 160 200 250 320 400 500	P	POT1 POT2 POT3	S2 S20	FENG	A
Ordering example								
528 941	DNCM	50	500	P	POT3	S20		A

Ordering table						
Size	32	50	Condi- tions	Code	Enter code	
M Module No.	528 940	528 941				
Basic function	Standard cylinder with displacement encoder			DNCM	DNCM	
Size [mm]	32	50		-...		
Stroke [mm]	100			-100		
	160			-160		
	200			-200		
	250			-250		
	320		1	-320		
	400		1	-400		
	500		1	-500		
Cushioning	Flexible cushioning rings/plates at both ends			-P	-P	
Encoder attachment position	Encoder underneath			-POT1		
	Encoder at side			-POT2		
	Encoder on top			-POT3		
O Type of piston rod	Through piston rod		1	-S2		
	Through, hollow piston rod		1	-S20		
Guide	Guide unit with ball bearing guide KF		2	-FENG		
Position sensing	Via proximity sensor			-A		

1 320, 400, 500, S2, S20
Not with guide FENG.

2 FENG Only with potentiometer POT2.

Transfer order code

End position controllers SPC11

Technical data

FESTO

Accessories for the package solution for DNCM horizontally mounted

For nominal strokes 80 ... 735 mm

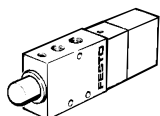
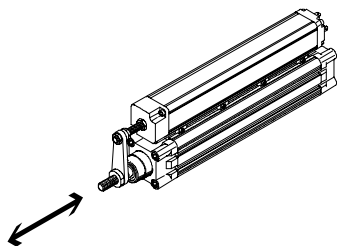

Ordering data

Nominal stroke DNCM-... [mm]	Proportional 5/3-way valve Type	Fittings ¹⁾				Compressed air tubing		Silencer ²⁾	
		for MPYE-5-...		DNCM		Part No.	Type	Part No.	Type
		Part No.	Type	Part No.	Type				
Ø 32 mm									
100 ... 400	MPYE-5-1/8-LF-010-B	153 004	QS-1/8-8	153 004	QS-1/8-8	152 587	PUN-8x1,25	2307	U-1/8
500	MPYE-5-1/8-HF-010-B								
Ø 50 mm									
100 ... 250	MPYE-5-1/8-LF-010-B	153 004	QS-1/8-8	153 005	QS-1/4-8	152 587	PUN-8x1,25	2307	U-1/8
320 ... 400	MPYE-5-1/8-HF-010-B								
500	MPYE-5-1/4-010-B	153 007	QS-1/4-10	153 007	QS-1/4-10	152 588	PUN-10x1,5	2316	U-1/4

1) Fittings sold only in packs of 10.

2) 2 pieces are required.

End position controllers SPC11

Technical data

Accessories for the package solution for DNCM horizontally mounted

For nominal strokes 80 ... 735 mm

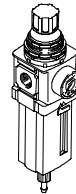
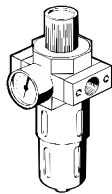

Ordering data								
Nominal stroke DNCM-... [mm]	Filter regulator, D series with filter cartridge 5 µm		Filter cartridge 5 µm D series		Filter regulator, MS series with filter cartridge 5 µm		Filter cartridge 5 µm MS series	
	Part No.	Type	Part No.	Type	Part No.	Type	Part No.	Type
Ø 32 mm								
100 ... 500	162 719	LFR-¼-D-5M-MINI	159 640	LFP-D-MINI-5M	529 152	MS4-LFR-¼-D7-CRM-AS	534 501	MS4-LFP-C
Ø 50 mm								
100 ... 400	162 719	LFR-¼-D-5M-MINI	159 640	LFP-D-MINI-5M	529 152	MS4-LFR-¼-D7-CRM-AS	534 501	MS4-LFP-C
500	162 721	LFR-¾-D-5M-MIDI	159 594	LFP-D-MIDI-5M	529 204	MS6-LFR-¼-D7-CRM-AS	534 499	MS6-LFP-C

End position controllers SPC11

Technical data

Ordering example for swivel module DSMI

A workpiece with a mass moment of inertia of $400 \text{ kgm}^2 \times 10^{-4}$ is to be moved on an unloading station. The workpiece gripper attached to the

shaft of the swivel module has a mass moment of inertia of $230 \text{ kgm}^2 \times 10^{-4}$. The total mass moment of inertia to be moved is therefore $630 \text{ kgm}^2 \times 10^{-4}$.

The swivel angle is 250° . The travel time is to be < 1 second.



Selection and ordering aid for Soft Stop and ProDrive
www.festo.com/en/engineering
or the Pneumatics Catalogue on CD-ROM

Step 1: Specifying the swivel angle

The maximum swivel angle of the swivel modules DSMI-25-270 and DSMI-40-270 is 270° and can be fully exploited. The integrated displacement encoder is appropriately designed.

Step 2: Specifying the drive

DSMI-40-270 must be used for the total mass moment of inertia of $630 \text{ kgm}^2 \times 10^{-4}$ to be moved horizontally → 5 / 1.4-33.

Step 3: Specifying a proportional 5/3-way valve

As can be seen from the table → 5 / 1.4-33, the proportional 5/3-way valve MPYE-5-1/8-LF-010B is generally required for swivel module DSMI-40-270.



Note
Remember when selecting the drive mounting components that some of these are not backlash-free and therefore cannot be used with the Soft Stop system. The drives must be mounted directly.

Step 4: Completing the order information

To order a complete system you must add the data for the end position controller, valve and controller cables and manual (if required). The complete ordering data for our example can be found on → 5 / 1.4-33. A manual should normally be ordered. If you already have one, leave the appropriate box blank, indicating an express waiver of a manual.

Step 5: Determining the travel time

To calculate the travel time use the "Soft Stop" software tool. The travel time for the ordering example is 0.89 seconds.



Note
Check that the loads placed on the drive by a gripper during the movement process do not exceed permissible limits. To carry out simulation quickly and easily, use the Soft Stop software tool.

Ordering data					
Swivel module		Proportional 5/3-way valve		End position controller	
Part No.	Type	Part No.	Type	Part No.	Type
192 271	DSMI-40-270	151 692	MPYE-5-1/8-LF-010B	192 217	SPC11-POT-LWG
Valve cable		Controller cable		Manual	
Part No.	Type	Part No.	Type	Part No.	Type
170 238	KMPYE-AIF-1-GS-GD-2	177 674	KMPV-SUB-D-15-10	196 723	P.BE-SPC11-SYS-DE
				196 741	P.BE-SPC11-DSMI-DE

End position controllers SPC11

Technical data

Step 1 and 2:		
Swivel module with integrated displacement encoder	DSMI-25-270	DSMI-40-270
Swivel angle	270°	
Max. permissible mass moment of inertia, horizontal	300 kgm ² x10 ⁻⁴	1200 kgm ² x10 ⁻⁴
Part No.	192 270	192 271

Step 3:				
Proportional 5/3-way valves ¹⁾	Part No.	Type	Part No.	Type
	154 200	MPYE-5-M5-010B	151 692	MPYE-5-1/8-LF-010B

Step 4:				
End position controllers and accessories		Part No.	Type	Brief description
End position controller	SPC11	192 217	SPC11-POT-LWG	
		526 908	SPC11-POT-LWG-ASI	
Cable	Valve	170 238	KMPYE-AIF-1-GS-GD-2	Cable length 2 m
		170 239	KMPYE-AIF-1-GS-GD-0,3	Cable length 0.3 m
	SPC11/PLC	177 673	KMPV-SUB-D-15-5	Cable length 5 m
		177 674	KMPV-SUB-D-15-10	Cable length 10 m
	SPC11-ASI/PLC	18 940	KASI-1,5-Y-100	For logic voltage, cable length 100 m (yellow)
		18 941	KASI-1,5-Z-100	For load voltage, cable length 100 m (black)

 **Note**
Manuals → 5 / 1.4-37

1) Technical data and dimensions → 5 / 1.5-1.

End position controllers SPC11

Technical data

Accessories for the package solution for DSMI horizontally mounted

For swivel angle 0° ... 270°

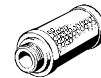
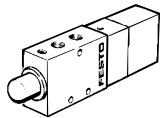
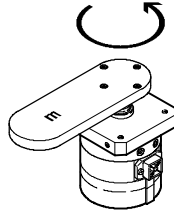

Ordering data

Swivel angle DSMI	Proportional 5/3-way valve Type	Fittings ¹⁾				Compressed air tubing		Silencer ²⁾	
		for MPYE-5-...		DSMI		Part No.	Type	Part No.	Type
		Part No.	Type	Part No.	Type				
Ø 25 mm									
0° ... 270°	MPYE-5-M5-010-B	153 306	QSM-M5-6	153 306	QSM-M5-6	152 586	PUN-6x1	4645	U-M5
Ø 40 mm									
0° ... 270°	MPYE-5-1/8-LF-010-B	153 004	QS-1/8-8	153 004	QS-1/8-8	152 587	PUN-8x1,25	2307	U-1/8

1) Fittings sold only in packs of 10.

2) 2 pieces are required.

End position controllers SPC11

Technical data

Accessories for the package solution for DSMI horizontally mounted

For swivel angle 0° ... 270°

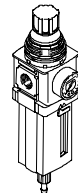
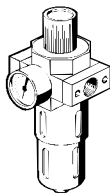

Ordering data								
Swivel angle	Filter regulator, D series with filter cartridge 5 µm		Filter cartridge 5 µm D series		Filter regulator, MS series with filter cartridge 5 µm		Filter cartridge 5 µm MS series	
DSMI	Part No.	Type	Part No.	Type	Part No.	Type	Part No.	Type
Ø 25 mm								
0° ... 270°	162 719	LFR-¼-D-5M-MINI	159 640	LFP-D-MINI-5M	529 152	MS4-LFR-¼-D7-CRM-AS	534 501	MS4-LFP-C
Ø 40 mm								
0° ... 270°	162 719	LFR-¼-D-5M-MINI	159 640	LFP-D-MINI-5M	529 152	MS4-LFR-¼-D7-CRM-AS	534 501	MS4-LFP-C

End position controllers SPC11

Technical data

FESTO

Ordering data – Manuals			
System description		Part No.	Type
End position controller			
SPC11	German	196 723	P.BE-SPC11-SYS-DE
	English	196 724	P.BE-SPC11-SYS-EN
	French	196 727	P.BE-SPC11-SYS-FR
	Italian	196 726	P.BE-SPC11-SYS-IT
	Swedish	196 728	P.BE-SPC11-SYS-SV
	Spanish	196 725	P.BE-SPC11-SYS-ES
SPC11-ASI	German	529 064	P.BE-SPC11-SYS-ASI-DE
	English	529 065	P.BE-SPC11-SYS-ASI-EN
	French	529 068	P.BE-SPC11-SYS-ASI-FR
	Italian	529 067	P.BE-SPC11-SYS-ASI-IT
	Swedish	529 069	P.BE-SPC11-SYS-ASI-SV
	Spanish	529 066	P.BE-SPC11-SYS-ASI-ES
Drive-specific supplement for DGP/DGPL/DGPI/DGPIL			
SPC11	German	196 729	P.BE-SPC11-DGP-DE
	English	196 730	P.BE-SPC11-DGP-EN
SPC11-ASI	French	196 733	P.BE-SPC11-DGP-FR
	Italian	196 732	P.BE-SPC11-DGP-IT
	Swedish	196 734	P.BE-SPC11-DGP-SV
	Spanish	196 731	P.BE-SPC11-DGP-ES
	Drive-specific supplement for DNC		
SPC11	German	196 735	P.BE-SPC11-DNC-DE
	English	196 736	P.BE-SPC11-DNC-EN
SPC11-ASI	French	196 739	P.BE-SPC11-DNC-FR
	Italian	196 738	P.BE-SPC11-DNC-IT
	Swedish	196 740	P.BE-SPC11-DNC-SV
	Spanish	196 737	P.BE-SPC11-DNC-ES
	Drive-specific supplement for DNCM		
SPC11	German	532 790	P.BE-SPC11-DNCM-DE
	English	532 791	P.BE-SPC11-DNCM-EN
SPC11-ASI	French	532 794	P.BE-SPC11-DNCM-FR
	Italian	532 793	P.BE-SPC11-DNCM-IT
	Swedish	532 795	P.BE-SPC11-DNCM-SV
	Spanish	532 792	P.BE-SPC11-DNCM-ES
	Drive-specific supplement for DSMI		
SPC11	German	196 741	P.BE-SPC11-DSMI-DE
	English	196 742	P.BE-SPC11-DSMI-EN
SPC11-ASI	French	196 745	P.BE-SPC11-DSMI-FR
	Italian	196 744	P.BE-SPC11-DSMI-IT
	Swedish	196 746	P.BE-SPC11-DSMI-SV
	Spanish	196 743	P.BE-SPC11-DSMI-ES

End position controllers SPC11

Technical data

Converting existing systems

What are the points to note when converting existing systems that use the pneumatic drives DGP/DGPL or DNC?

Optimum system behaviour is guaranteed by Festo's uniquely specified package solutions, in which

all components are harmonised. When converting existing systems, observe the following points:

Where could system behaviour possibly change when an existing system is converted?

In normal cases, the entire nominal stroke is used, including the internal

cushioning length (PPV); no stroke reserve is available.

What should be noted when installing the pneumatics?

- Make sure that the system configuration is symmetrical, i.e. that the tubing used to connect the compressed air supply to each end of the cylinder is of identical length.

- No flow controls between the valve and cylinder.
- Open the end-position cushioning (PPV) 100%.

Accessories and tubing diameters can be found in the description for the respective package solution.

What should be noted when installing the electrics?

As far as the electrical actuation is concerned, the Soft Stop system behaves like a standard pneumatic

system with a double solenoid valve and two proximity sensors.

For further information see the manual
System description:
SPC11-... → 5 / 1.4-37.

Does the control program need to be adapted?

Existing systems which have provision for two digital inputs/outputs can be

converted without adaptation of the control program.

What proportional 5/3-way valve should be selected for the conversion project?

Exactly the same valve as specified in the package solutions on
→ 5 / 1.4-17 or 5 / 1.4-23.

What end position controller is suitable for each drive or displacement encoder?

End position controller	Drive	Displacement encoder
SPC11-POT-TLF	DGP/DGPL	MLO-POT-...-TLF
SPC11-POT-TLF-ASI	DNCM	Adapted
SPC11-POT-LWG	DNC	MLO-POT-...-LWG
SPC11-POT-LWG-ASI	DSMI	Integrated
SPC11-MTS-AIF	DGP/DGPL	MME-MTS-...-AIF
SPC11-MTS-AIF-ASI	DGPI/DGPIL	Integrated

Pneumatic linear drives DGP/DGPL

Max. nominal stroke [mm]	215	290	350	440	490	590	735	985	1230	1475	1720	1965
Displacement encoder length	225	300	360	450	500	600	750	1000	1250	1500	1750	2000

Pneumatic drives DNC

Max. nominal stroke [mm]	80	100	125	160	200	250	320	400	500	650
Potentiometer length	100	150	150	225	225	300	360	450	600	750