

- Multi-axis and drive combinations
- With guide
- Recirculating ball bearing guide
- Individualised position sensing and end-position cushioning

Slide units SLZ, with guide rods

Key features

Version

The slide in this unit is moved by a standard/round cylinder.

The modular system allows for individualised end-position cushioning and end-position sensing solutions.

Basic unit

SLZ-...-G

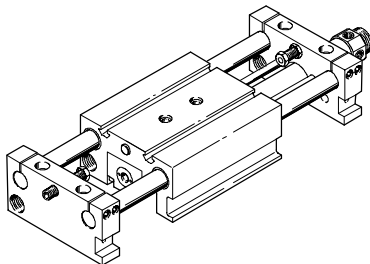

SLZ-...-K for short strokes

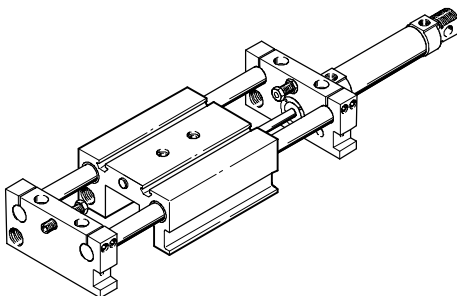

Standard unit

SLZ-...-S

SLZ-...-T, for short strokes with two self-adjusting shock absorbers and two inductive proximity sensors with PNP output

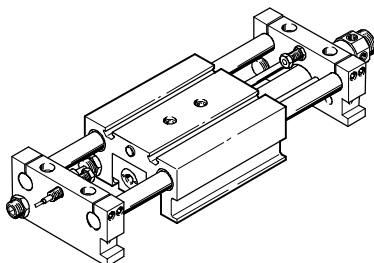

Slide units SLZ, with guide rods

Peripherals overview

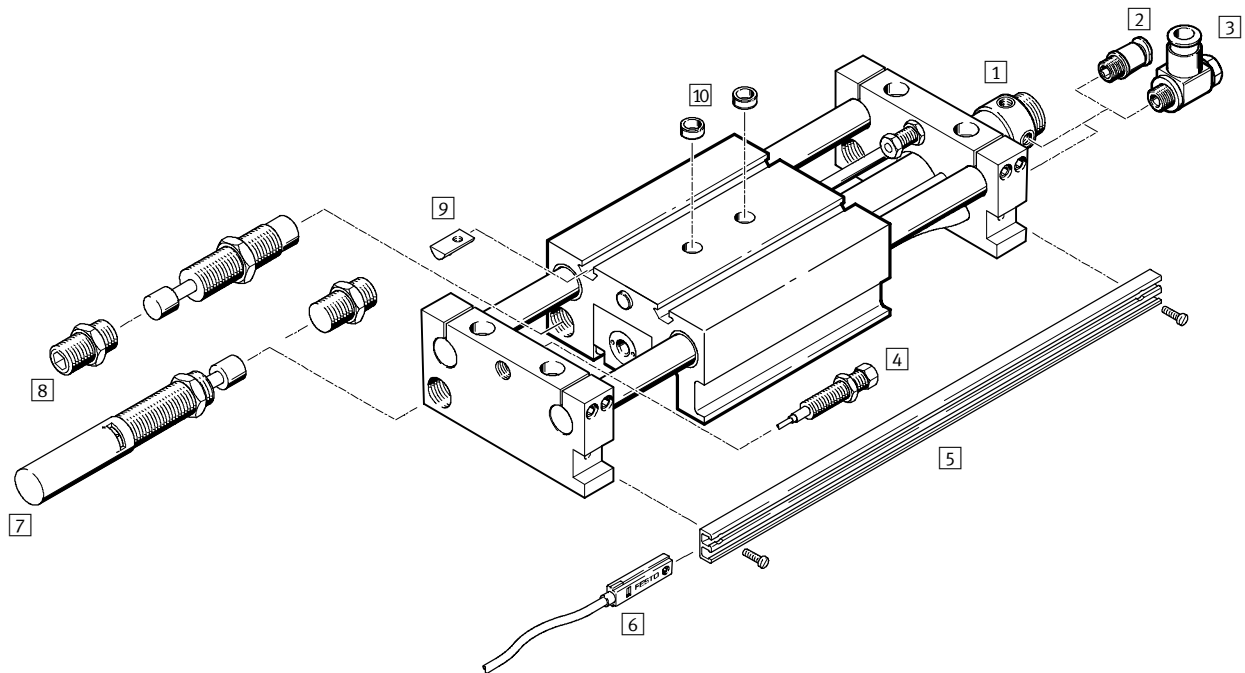

Accessories				
	Brief description	Piston Ø 10 ... 25 mm	Piston Ø 32 ... 50 mm	→ Page
1	Standard cylinder DSNU	■	-	1 / 6.1-70
	Round cylinder DSW	-	■	1 / 6.1-70
2	Push-in fitting QS	■	■	Volume 3
3	One-way flow control valve GRLA	■	■	1 / 6.1-72
4	Switching stop with proximity sensor SL-...-SIE-PS/SL-...-SIE-NS	■	■	1 / 6.1-70
5	Mounting rail SLZS	■	■	1 / 6.1-70
6	Proximity sensor SME/SMT-8	■	■	1 / 6.1-71
7	Shock absorber kit, adjustable SLZ-...-KF-A	■	■	1 / 6.1-69
8	Shock absorber kit, self-adjusting SLZ-...-YSR-C	■	■	1 / 6.1-69
9	Slot nut NST	■	■	1 / 6.1-70
10	Centring sleeve ZBH	■	■	1 / 6.1-70

Slide units SLZ, with guide rods

Type code

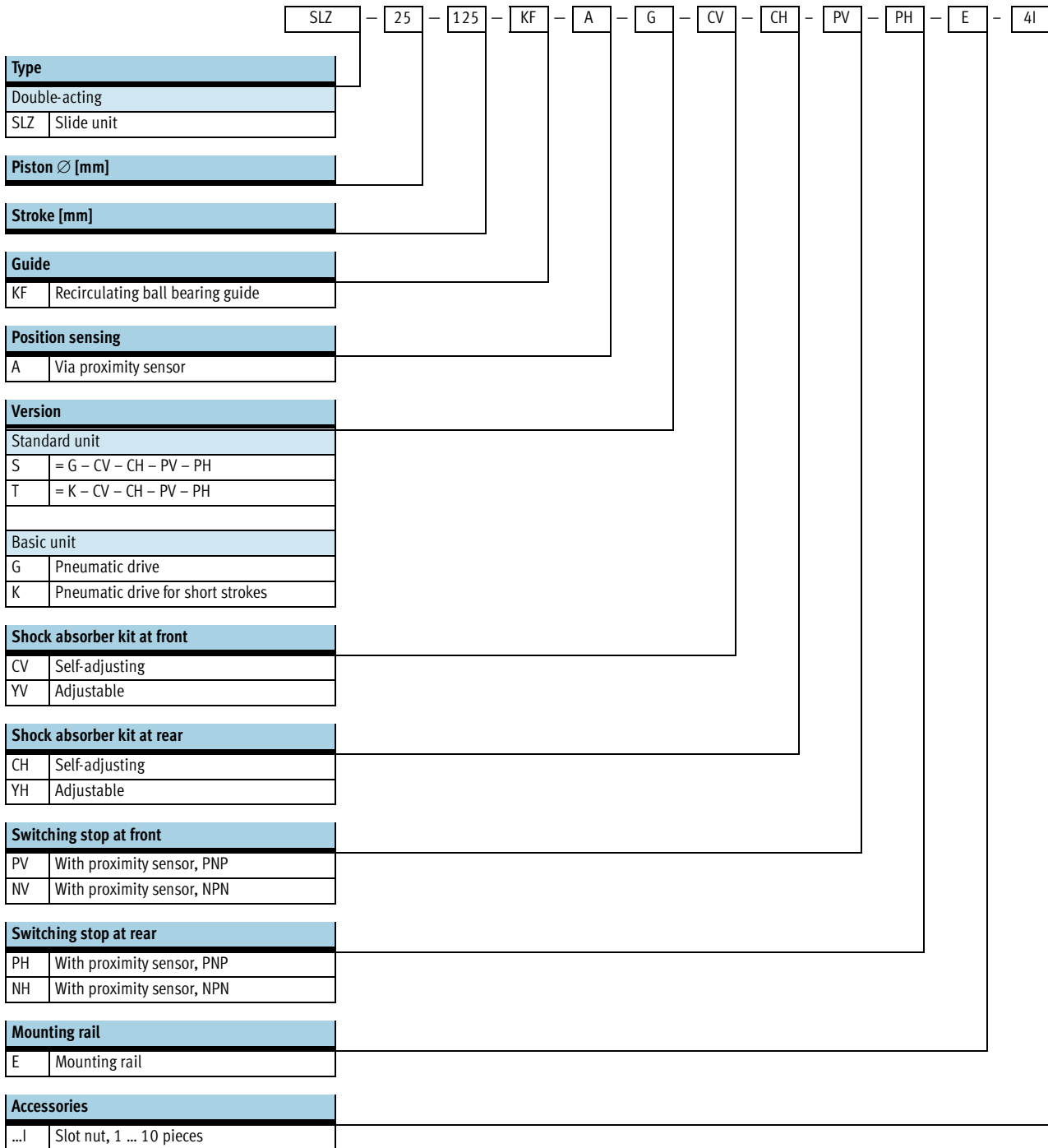

Slide units SLZ, with guide rods

Technical data

Function

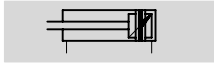

www.festo.com/en/Spare_parts_service

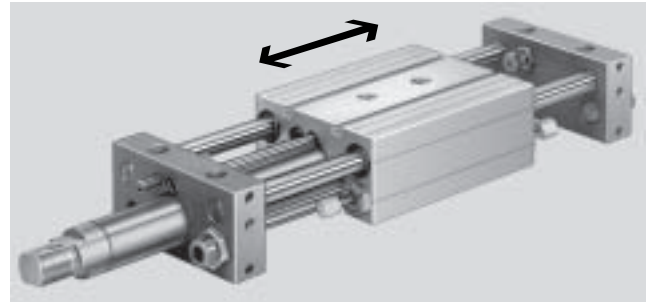

- \varnothing - Diameter
10 ... 50 mm
- | - Stroke length
10 ... 500 mm

General technical data								
Piston \varnothing		10	16	20	25	32	40	50
Stroke	SLZ-...-G/-S [mm]	60 ... 100	70 ... 200	90 ... 320	100 ... 500			
	SLZ-...-K/-T [mm]	10 ... 100	10 ... 200	10 ... 320	10 ... 500			
Pneumatic connection		M5			G $\frac{1}{8}$		G $\frac{1}{4}$	
Mode of operation		Double-acting						
Constructional design		Slide unit						
	\varnothing 10 ... 25	Standard cylinder						
	\varnothing 32 ... 50	Round cylinder						
Drive cushioning		Non-adjustable at both ends		-				
		-		Adjustable at both ends				
End-position cushioning via shock absorber		Self-adjusting at both ends						
		-			Adjustable at both ends			
Position sensing		Via proximity sensor						
Type of mounting		Via through-holes						
		Via female thread						
Mounting position		Any						
Protection against torsion/guide		Guide rods with slide/ball bearing guide						

Operating and environmental conditions								
Piston \varnothing		10	16	20	25	32	40	50
Operating medium		Filtered compressed air, lubricated or unlubricated						
Operating pressure [bar]		2.5 ... 10				1.5 ... 10		
Ambient temperature ¹⁾ [°C]		-20 ... +80						

1) Note operating range of proximity sensors.

Forces [N]								
Piston \varnothing		10	16	20	25	32	40	50
Theoretical force at 6 bar, advancing		47	121	188	295	483	754	1178
Theoretical force at 6 bar, retracting		40	104	158	247	415	633	990

Slide units SLZ, with guide rods

Technical data



Permissible dynamic load

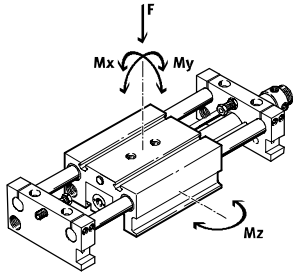

F = Load
 $M \geq M_x$
 $M \geq M_y$
 $M \geq M_z$

Permissible effective load F as a function of the stroke l

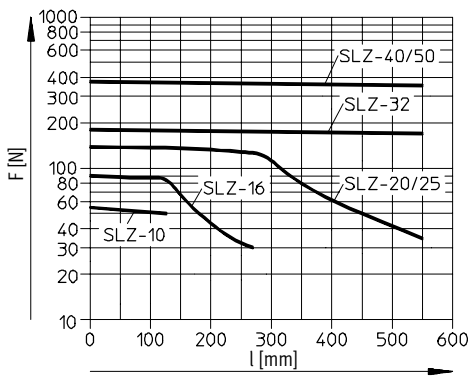

Permissible torque M as a function of the stroke l

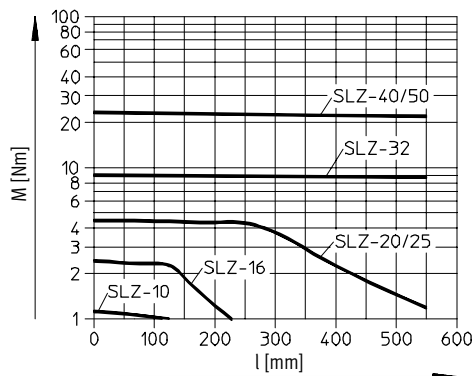

Permissible shock absorber load F as a function of the impact velocity v

with horizontal installation

$F \geq m_L \times g$

$g = 9.81 \text{ N/mm}^2$

$m_L = \text{Load [kg]}$

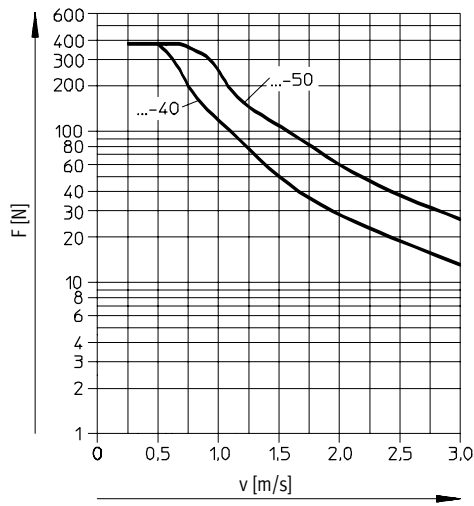
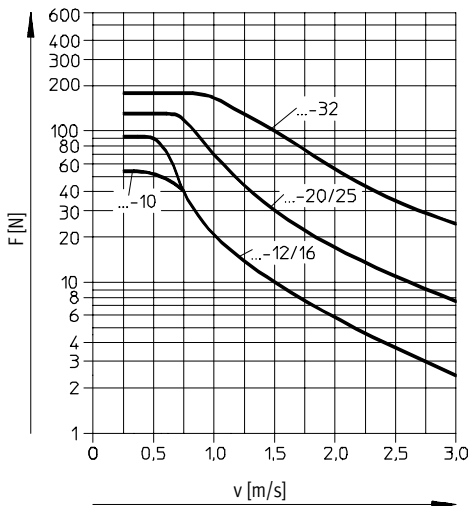

Slide units SLZ, with guide rods

Technical data

Permissible shock absorber load F as a function of the impact velocity v with vertical installation

$F \geq (m_L + m_E) \times g$

 $g = 9.81 \text{ N/mm}^2$

 $m_E = \text{Moving load (dead weight) [kg]}$

 $m_L = \text{Load [kg]}$

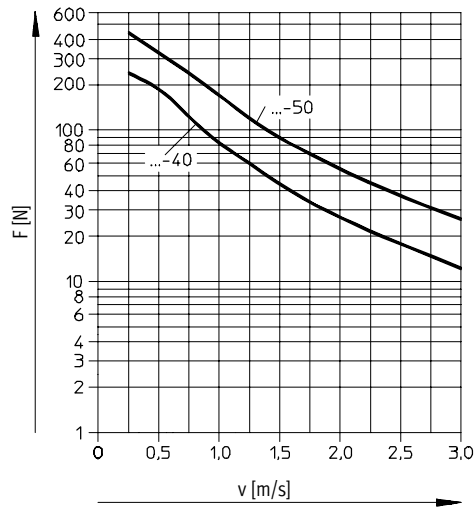
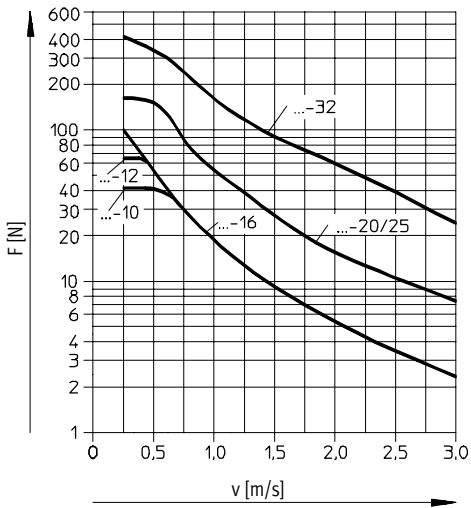

Weights [g]							
Piston Ø	10	16	20	25	32	40	50
Product weight with 0 mm stroke	780	1030	2090	2150	6020	7680	9540
Additional weight per 10 mm stroke	10	13	25	29	64	96	110
Moving load	350	470	930	930	2500	3000	4000

Materials

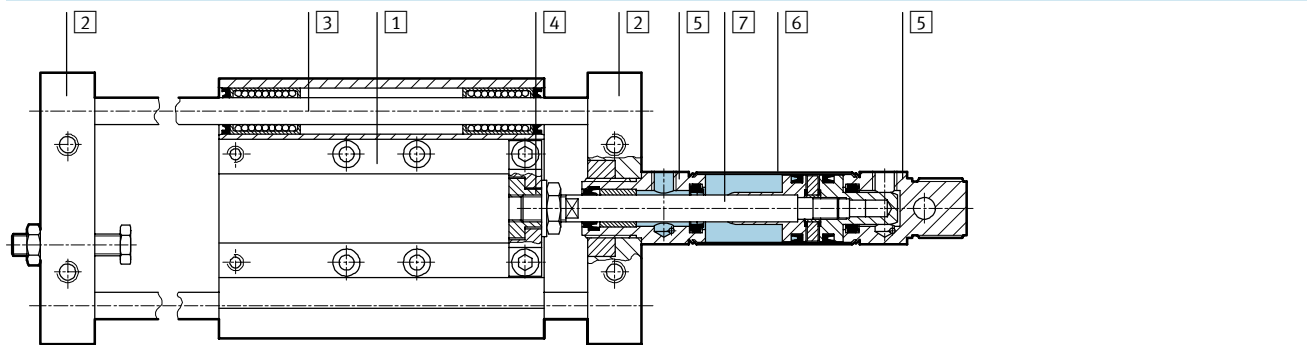

Slide unit			
1	Slide	Wrought aluminium alloy	
2	End plate	Wrought aluminium alloy	
3	Guide rod	Tempered steel	
4	Coupling	Steel	
5	Bearing and end caps	Wrought aluminium alloy	
6	Cylinder barrel	High-alloy stainless steel	
7	Piston rod	Ø 10 ... 25	High-alloy stainless steel
		Ø 32 ... 50	High-alloy steel
-	Seals	Polyurethane, nitrile rubber	

Slide units SLZ, with guide rods

Technical data



Dimensions

Download CAD data → www.festo.com/en/engineering

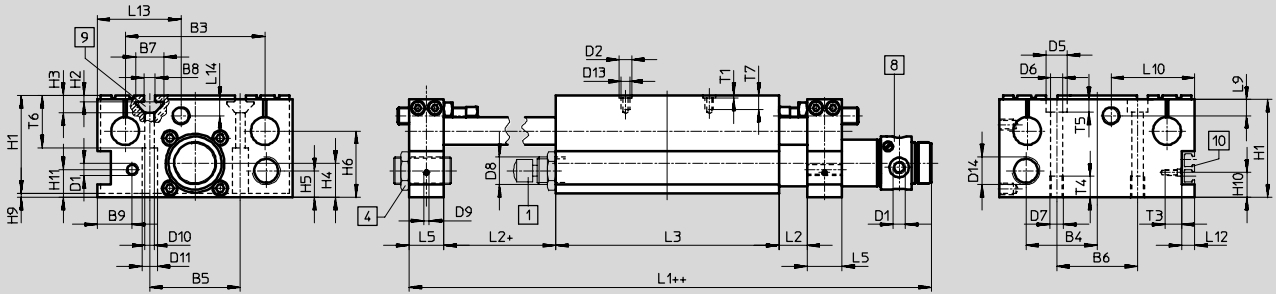

View A

SLZ-40/50

SLZ-10 ... 32

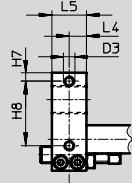
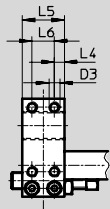

SLZ-...K/T

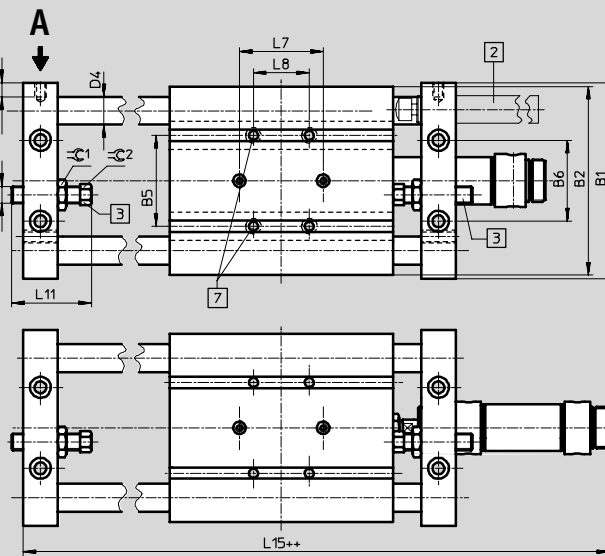

- 1 Self-adjusting shock absorber, for front and rear mounting
- 2 Adjustable shock absorber, for front and rear mounting on the end plate
- 3 Switching stop with proximity sensor, PNP/NPN, for front and rear mounting

- 4 Shock absorber stop
- 7 Mounting thread/through-hole
- 8 Ø 10 ... 25: Drive DSNU
Ø 32 ... 50: Drive DSW
- 9 Slot nut
- 10 Mounting rail for proximity sensor SME/SMT-8

Compensating coupling for radial and axial alignment, attached to end of piston rod

+ = plus stroke length
++ = plus 2x stroke length

Slide units SLZ, with guide rods

Technical data

∅ [mm]	B1	B2	B3	B4	B5	B6	B7	B8	B9	D1	D2 ∅ H7	D3	D4 ∅ h6	D5 ∅	D6 ∅
10	63	60	42	21.5	16	27	11.6	5	12	M5	3	M5	8	8	4.3
16	74	71	53	26.5	26	35	11.6	5	13	M5	9	M5	8	10	5.3
20	100	96	72	36.5	40	47	11.6	5	17	G $\frac{1}{8}$	9	M6	12	11	6.8
25	100	96	72	36.5	40	47	11.6	5	17	G $\frac{1}{8}$	9	M6	12	11	6.8
32	140	135	100	51	65	58	20	8	30	G $\frac{1}{8}$	9	M8	20	15	8.5
40	166	160	118	63	75	78	20	8	32	G $\frac{1}{4}$	9	M6	25	15	8.5
50	176	170	126	66	80	84	20	8	33	G $\frac{1}{4}$	9	M6	25	15	8.5

∅ [mm]	D7	D8	D9	D10 ∅	D11 ∅	D12	D13	D14	H1	H2	H3	H4	H5
10	M6	M12x1	M4	5.5	9	M6x0.75	-	M10x0.75	40	1.8	6.4	16.3	13
16	M6	M12x1	M4	5.5	9	M6x0.75	M6	M10x0.75	40	1.8	6.4	16.3	12
20	M8	M16x1	M4	5.5	10	M8x1	M6	M15x1	50	1.8	6.4	20	16
25	M8	M16x1	M4	5.5	10	M8x1	M6	M15x1	50	1.8	6.4	20	16
32	M10	M22x1.5	M4	6.6	11	M12x1	M6	M20x1.25	70	4.5	12.5	24.5	19
40	M10	M22x1.5	M4	6.6	11	M12x1	M6	M20x1.25	75	4.5	12.5	26.5	19
50	M10	M26x1.5	M4	9	14	M12x1	M6	M24x1.25	80	4.5	12.5	32	22

∅ [mm]	H6	H7	H8	H9	H10	H11	L1	L2	L3	L4	L5	L6	L7	L8	L9
10	28.5	4.5	31	2	19.8	12	123.5	12	85	5	10	-	16	16	7.7
16	27.5	4.5	31	2	21	12	141	12	85	7.5	15	-	40	19	9
20	36	5	40	2	26.2	16	175	16	120	10	20	-	40	26	11.5
25	36	5	40	2	26.2	16	178.5	16	120	10	20	-	40	26	11.5
32	47.5	6	46	3	18.8	20	214	20	160	12.5	25	-	40	40	11.5
40	51	5.5	51.5	3	17.8	23.5	246	20	180	6.5	25	12	40	50	12
50	57	7	55	3	22.8	19	273	25	192	6.5	25	12	40	60	9

∅ [mm]	L10	L11	L12	L13	L14	L15	T1	T2	T3	T4	T5	T6	T7	≈C1	≈C2
10	26.8	33	-	26.8	7.7	187	5	8	11	10	4.6	11.2	-	10	8
16	28.7	33	-	-	-	212	2.1	6.5	12	10	5.7	11	8	10	8
20	36.5	45	-	-	-	280	2.1	9	12	12	6.8	15.8	8	13	11
25	36.5	45	-	-	-	283	2.1	9	12	12	6.8	15.8	8	13	11
32	70	57	9.5	-	-	360	2.1	10	12	15	9	37.5	10	19	13
40	83	57	10	-	-	399	2.1	10	12	16	9	22	10	19	13
50	68	57	10	-	-	430	2.1	10	12	16	9	16.5	10	19	13

Slide units SLZ, with guide rods

Ordering data – Modular products



Drives with linear guides
Slides

6.1

M Mandatory data →

Module No.	Function	Piston \varnothing	Stroke	Guide	Position sensing	Basic unit
150 922	SLZ	10	10 ... 500	KF	A	K G
150 081						
150 082						
150 083						
150 084						
150 085						
150 086						
150 086						
Ordering example						
150 922	SLZ	- 10	- 100	- KF	- A	- K

Ordering table											
Size	10	16	20	25	32	40	50	Condi- tions	Code	Enter code	
M	Module No.	150 922	150 081	150 082	150 083	150 084	150 085	150 086			
	Function	Linear unit								SLZ	SLZ
	Piston \varnothing [mm]	10	16	20	25	32	40	50	-...		
	Stroke [mm] with basic unit K	10 ... 100	10 ... 200	10 ... 320		10 ... 500			-...		
	Stroke [mm] with basic unit G	60 ... 100	70 ... 200	90 ... 320	100 ... 500			-...			
	Guide	Recirculating ball bearing guide								-KF	-KF
	Position sensing	Via proximity sensor								-A	-A
	Basic unit	Linear unit with pneumatic drive for short strokes								-K	
		Linear unit with pneumatic drive								-G	

Transfer order code

SLZ - - - KF - A - -

Slide units SLZ, with guide rods

Ordering data – Modular products

Options					
Shock absorber at front	Shock absorber at rear	Sensor at front	Sensor at rear	Mounting rail	Slot nut
CV YV	CH YH	PV NV	PH NH	E	...I
YV	- YH	- PV	- PH	- E	- 4I

Ordering table											
Size	10	16	20	25	32	40	50	Condi- tions	Code	Enter code	
Shock absorber	at front	Self-adjusting shock absorber, with stop at front								-CV	
		Adjustable shock absorber, with stop at front								-YV	
	at rear	Self-adjusting shock absorber, with stop at rear								-CH	
		Adjustable shock absorber, with stop at rear								-YH	
Sensor (bonded)	at front	Inductive sensor with 2.5 m cable, PNP, with stop sleeve at front								-PV	
		Inductive sensor with 2.5 m cable, NPN, with stop sleeve at front								-NV	
	at rear	Inductive sensor with 2.5 m cable, PNP, with stop sleeve at rear								-PH	
		Inductive sensor with 2.5 m cable, NPN, with stop sleeve at rear								-NH	
Mounting rail	Mounting rail								-E		
Slot nut	1 ... 10								-...I		

Transfer order code

- - - - -

Slide units SLZ, with guide rods

Ordering data – Modular products, package solution



Drives with linear guides
Slides

6.1

Mandatory data						
Module No.	Function	Piston \varnothing	Stroke	Guide	Position sensing	Standard unit
150 922	SLZ	10	10 ... 500	KF	A	T
150 081		16				S
150 082		20				
150 083		25				
150 084		32				
150 085		40				
150 086		50				
Ordering example						
150 081	SLZ	- 16	- 200	- KF	- A	- T

Ordering table											
Size	10	16	20	25	32	40	50	Condi- tions	Code	Enter code	
M	Module No.	150 922	150 081	150 082	150 083	150 084	150 085	150 086			
	Function	Linear unit								SLZ	SLZ
	Piston \varnothing [mm]	10	16	20	25	32	40	50	-...		
	Stroke with package solution T [mm]	10 ... 100	10 ... 200	10 ... 320		10 ... 500			-...		
	Stroke with package solution S [mm]	60 ... 100	70 ... 200	90 ... 320	100 ... 500			-...			
	Guide	Recirculating ball bearing guide								-KF	-KF
	Position sensing	Via proximity sensor								-A	-A
	Package solution	Package solution T = K-CV-CH-PV-PH								-T	
		Package solution S = G-CV-CH-PV-PH								-S	

Transfer order code

	SLZ	-		-		-	KF	-	A	-	
--	-----	---	--	---	--	---	----	---	---	---	--

Slide units SLZ, with guide rods

FESTO

Accessories

Shock absorber kit

SLZ...-YSR-C, self-adjusting

(order code CV, CH)

Material:

YSR-8-8-C: Nickel-plated brass

YSR-12-12-C, YSR-16-20-C,

YSR-20-25-C: Galvanised steel

Free of copper, PTFE and silicone



Ordering data			
For Ø [mm]	including shock absorber → 1 / 9.0-2	Part No.	Type
10, 16	YSR-8-8-C	115 315	SLZ-16-YSR-C
20, 25	YSR-12-12-C	115 316	SLZ-25-YSR-C
32, 40	YSR-16-20-C	115 317	SLZ-32-YSR-C
50	YSR-20-25-C	115 318	SLZ-50-YSR-C

Shock absorber kit

SLZ...-KF-A, adjustable

(order code YV, YH)

Material:

Galvanised steel



Ordering data			
For Ø [mm]	including shock absorber → 1 / 9.0-2	Part No.	Type
20, 25	YSR-12-12	114 032	SLZ-25-KF-A
32, 40	YSR-16-20	114 033	SLZ-32-KF-A
50	YSR-20-25	114 034	SLZ-50-KF-A

Slide units SLZ, with guide rods

Accessories



Switching stop SL-...-SIE-PS

(order code PV, PH)

Kit with inductive proximity sensor
PNP

Switching stop SL-...-SIE-NS

(order code NV, NH)

Kit with inductive proximity sensor
NPN



Ordering data				
For Ø [mm]	Switch output	including proximity sensor → Volume 4	Part No.	Type
10, 16	PNP	SIEN-4B-PS-K-L	116 251	SL-10/16-SIE-PS
	NPN	SIEN-4B-NS-K-L	116 252	SL-10/16-SIE-NS
20, 25	PNP	SIEN-4B-PS-K-L	116 253	SL-20/25-SIE-PS
	NPN	SIEN-4B-NS-K-L	116 254	SL-20/25-SIE-NS
32, 40, 50	PNP	SIEN-6,5B-PS-K-L	117 525	SL-32/50-SIE-PS
	NPN	SIEN-6,5B-NS-K-L	117 526	SL-32/50-SIE-NS

Ordering data – Accessories						
	For Ø [mm]	Material	Order code	Part No.	Type	PU ¹⁾
Mounting rail SLZS for proximity sensor						
	10	Wrought aluminium alloy	E	150 924	SLZS-10-...-...	1
	16			150 916	SLZS-16-...-...	1
	20, 25			150 917	SLZS-25-...-...	1
	32			150 918	SLZS-32-...-...	1
	40			150 919	SLZS-40-...-...	1
	50			150 920	SLZS-50-...-...	1
Slot nut NST Technical data → 1 / 10.1-17						
	10 ... 25	Non-alloyed tempered steel	I	150 914	NST-5-M5	1
	32 ... 50	Free of copper, PTFE and silicone		150 915	NST-8-M6	1
Centring sleeve ZBH Technical data → 1 / 10.1-19						
	16 ... 50	Stainless steel	-	150 927	ZBH-9	10

1) Packaging unit quantity

Ordering data – Standard cylinders						Technical data DSNU → 1 / 1.1-2			
Designation	For Ø	Part No.	Type	Designation	For Ø	Part No.	Type		
Standard cylinder DSNU				Round cylinder DSW					
	10	14 325	DSNU-10-...-P-A		32	161 440	DSW-32-...-PPV-B		
	16	14 320	DSNU-16-...-PPV-A		40	161 488	DSW-40-...-PPV-B		
	20	14 321	DSNU-20-...-PPV-A		50	161 536	DSW-50-...-PPV-B		
	25	14 322	DSNU-25-...-PPV-A						

Core Range



Slide units SLZ, with guide rods



Accessories





FESTO

Drives with linear guides
Slides

6.1

Ordering data – Proximity sensors for slot type 8, magneto-resistive							Technical data → 1 / 10.2-13		
	Mounting	Switch output	Electrical connection			Cable length [m]	Part No.	Type	
			Cable	Plug M8	Plug M12				
Normally open contact									
	Insertable from above	PNP	3-wire	–	–	2.5	525 898	SMT-8F-PS-24V-K2,5-OE	☉
							525 909	SMT-8F-NS-24V-K2,5-OE	☉
		–	2-wire	–	–	2.5	525 908	SMT-8F-ZS-24V-K2,5-OE	☉
							PNP	–	3-pin
		NPN	–	–	–	0.3			
		PNP	–	–	3-pin	–	0.3	525 900	SMT-8F-PS-24V-K0,3-M12
Insertable from end	PNP							3-wire	–
		–	–	–	–	0.3	175 484	SMT-8-PS-S-LED-24-B	
Normally closed contact									
	Insertable from above	PNP	3-wire	–	–	7.5	525 911	SMT-8F-PO-24V-K7,5-OE	☉

Ordering data – Proximity sensors for slot type 8, magnetic reed							Technical data → 1 / 10.2-16		
	Mounting	Electrical connection			Cable length [m]	Part No.	Type		
		Cable	Plug M8						
Normally open contact									
	Insertable from above	3-wire	–	–	2.5	525 895	SME-8F-DS-24V-K2,5-OE	☉	
						5.0	525 897	SME-8F-DS-24V-K5,0-OE	☉
		2-wire	–	–	2.5	525 907	SME-8F-ZS-24V-K2,5-OE	☉	
						0.3	525 896	SME-8F-DS-24V-K0,3-M8D	☉
–	3-pin	–	2.5	150 855	SME-8-K-LED-24				
				0.3	150 857	SME-8-S-LED-24			
	Insertable from end	3-wire	–	–	2.5				
		–	3-pin	–	0.3				
Normally closed contact									
	Insertable from above	3-wire	–	–	7.5	525 906	SME-8F-DO-24V-K7,5-OE	☉	

Ordering data – Plug sockets							Technical data → 1 / 10.2-100		
	Mounting	Switch output		Connection	Cable length [m]	Part No.	Type		
		PNP	NPN						
Straight socket									
	M8 locknut	■	■	3-pin	2.5	159 420	SIM-M8-3GD-2,5-PU		
					5	159 421	SIM-M8-3GD-5-PU		
	M12 locknut	■	■	3-pin	2.5	159 428	SIM-M12-3GD-2,5-PU		
					5	159 429	SIM-M12-3GD-5-PU		
Angled socket									
	M8 locknut	■	■	3-pin	2.5	159 422	SIM-M8-3WD-2,5-PU		
					5	159 423	SIM-M8-3WD-5-PU		
	M12 locknut	■	■	3-pin	2.5	159 430	SIM-M12-3WD-2,5-PU		
					5	159 431	SIM-M12-3WD-5-PU		

Ordering data – Slot cover for slot type 8						
	Mounting	Length [m]	Part No.	Type		
	Insertable from above	2x 0.5	151 680	ABP-5-S		

 Core Range

Slide units SLZ, with guide rods

Accessories



Ordering data – One-way flow control valves			Technical data → Volume 2		
	Connection		Material	Part No.	Type
	Thread	For tubing OD			
	M5	3	Metal design	193 137	GRLA-M5-QS-3-D
		4		193 138	GRLA-M5-QS-4-D
		6		193 139	GRLA-M5-QS-6-D
	G1/8	3		193 142	GRLA-1/8-QS-3-D
		4		193 143	GRLA-1/8-QS-4-D
		6		193 144	GRLA-1/8-QS-6-D
		8		193 145	GRLA-1/8-QS-8-D
	G1/4	6		193 146	GRLA-1/4-QS-6-D
		8		193 147	GRLA-1/4-QS-8-D
		10		193 148	GRLA-1/4-QS-10-D

Drives with linear guides
Slides

6.1