

Pressure sensors SDE1, with display



- Five pressure measuring ranges
- Measurement of relative or differential pressure
- Switch outputs PNP, NPN and with analogue current or voltage output
- LCD or illuminated LCD display
- Wide range of connection and mounting options

Pressure sensors SDE1, with display

Product range overview – Pre-assembled pressure sensors

Pressure measuring range	Electrical output				Display, setting		Electrical connection	
	1 switch output PNP	2 switch outputs PNP	1 switch output PNP and 0 ... 10 V analogue	1 switch output PNP and 4 ... 20 mA analogue	LCD	Illuminated LCD	M8x1	M12x1
0 ... -1 bar	Female thread G $\frac{1}{8}$, for H-rail mounting, relative pressure measurement							
	■	-	-	-	■	-	■	-
	-	■	-	-	■	-	■	-
	-	-	■	-	■	-	■	-
	■	-	-	-	-	■	■	-
	-	■	-	-	-	■	■	-
	-	-	■	-	-	■	■	-
	Female thread G $\frac{1}{8}$, for wall or surface mounting, relative pressure measurement							
	■	-	-	-	-	■	-	■
	-	-	-	■	-	■	■	-
	-	-	-	■	-	■	-	■
	Push-in fitting QS-4, for H-rail mounting, differential pressure and relative pressure measurement							
	■	-	-	-	■	-	■	-
	-	■	-	-	■	-	■	-
	-	-	■	-	■	-	■	-
	■	-	-	-	-	■	■	-
	-	■	-	-	-	■	■	-
	-	-	■	-	-	■	■	-

Pressure measuring range	Electrical output				Display, setting		Electrical connection	
	1 switch output PNP	2 switch outputs PNP	1 switch output PNP and 0 ... 10 V analogue	1 switch output PNP and 4 ... 20 mA analogue	LCD	Illuminated LCD	M8x1	M12x1
0 ... 2 bar	Female thread G $\frac{1}{8}$, for wall or surface mounting, relative pressure measurement							
	■	-	-	-	-	■	■	-
	-	■	-	-	-	■	■	-
	Push-in fitting QS-4, for wall or surface mounting, differential pressure and relative pressure measurement							
-	■	-	-	-	■	-	■	-

Pressure measuring range	Electrical output				Display, setting		Electrical connection	
	1 switch output PNP	2 switch outputs PNP	1 switch output PNP and 0 ... 10 V analogue	1 switch output PNP and 4 ... 20 mA analogue	LCD	Illuminated LCD	M8x1	M12x1
0 ... 6 bar	Female thread G $\frac{1}{8}$, for wall or surface mounting, relative pressure measurement							
	■	-	-	-	-	■	■	-
-	■	-	-	-	-	■	■	-

 **Note**
Additional variants and accessories can be configured and ordered through the SDE1 modular system
➔ 4 / 8.2-92.

Pressure sensors SDE1, with display

Product range overview – Pre-assembled pressure sensors

Pressure measuring range	Electrical output					Display, setting		Electrical connection	
	1 switch output PNP	2 switch outputs PNP	1 switch output PNP and 0 ... 10 V analogue	1 switch output PNP and 4 ... 20 mA analogue	2 switch outputs PNP and 1 switch output 4 ... 20 mA analogue	LCD	Illuminated LCD	M8x1	M12x1
0 ... 10 bar	Male thread R $\frac{1}{8}$, mounting on service unit (MS or D series), relative pressure measurement								
	■	-	-	-	-	■	-	■	-
	-	■	-	-	-	■	-	■	-
	-	-	■	-	-	■	-	■	-
	■	-	-	-	-	-	■	■	-
	-	■	-	-	-	-	■	■	-
	-	-	■	-	-	-	■	■	-
	■	-	-	-	-	-	■	-	■
	Male thread R $\frac{1}{4}$, mounting on service unit (MS or D series), relative pressure measurement								
	■	-	-	-	-	■	-	■	-
	-	■	-	-	-	■	-	■	-
	-	-	■	-	-	■	-	■	-
	■	-	-	-	-	-	■	■	-
	-	■	-	-	-	-	■	■	-
	-	-	■	-	-	-	■	■	-
	■	-	-	-	-	-	■	-	■
	Female thread G $\frac{1}{8}$, for H-rail mounting, relative pressure measurement								
	■	-	-	-	-	■	-	■	-
	-	■	-	-	-	■	-	■	-
	-	-	■	-	-	■	-	■	-
	■	-	-	-	-	-	■	■	-
	-	■	-	-	-	-	■	■	-
	-	-	■	-	-	-	■	■	-
	Female thread G $\frac{1}{8}$, for wall or surface mounting, relative pressure measurement								
	-	-	■	-	-	-	■	■	-
	■	-	-	-	-	-	■	-	■
	-	-	-	■	-	-	■	■	-
	-	-	-	■	-	-	■	-	■
	-	-	-	-	■	-	■	-	■
	Push-in fitting QS-4, for H-rail mounting, differential pressure and relative pressure measurement								
	■	-	-	-	-	■	-	■	-
	-	■	-	-	-	■	-	■	-
	-	-	■	-	-	■	-	■	-
	■	-	-	-	-	-	■	■	-
	-	■	-	-	-	-	■	■	-
	-	-	■	-	-	-	■	■	-
	Push-in fitting QS-4, for front panel mounting, differential pressure and relative pressure measurement								
	■	-	-	-	-	-	■	■	-
	-	■	-	-	-	-	■	-	■
	■	-	-	-	-	-	■	■	-
	-	■	-	-	-	-	■	-	■

Pressure sensors SDE1, with display

Type codes

		SDE1	-	D10	-	G2	-	W18	-	L	-	P1	-	M12	-	G5
Type																
SDE1	Pressure sensor with display															
Pressure range																
V1	0 ... -1 bar															
B2	-1 ... +1 bar															
D2	0 ... 2 bar															
D6	0 ... 6 bar															
D10	0 ... 10 bar															
Absolute accuracy																
G2	Accuracy 2%															
Pneumatic connection, mounting, measured variable																
R18	Male thread R $\frac{1}{8}$, mounting on service unit (MS or D series), relative pressure measurement															
R14	Male thread R $\frac{1}{4}$, mounting on service unit (MS or D series), relative pressure measurement															
H18	Female thread G $\frac{1}{8}$, for H-rail mounting, relative pressure measurement															
W18	Female thread G $\frac{1}{8}$, for wall or surface mounting, relative pressure measurement															
FQ4	Push-in fitting QS-4, for front panel mounting, differential pressure and relative pressure measurement															
HQ4	Push-in fitting QS-4, for H-rail mounting, differential pressure and relative pressure measurement															
WQ4	Push-in fitting QS-4, for wall or surface mounting, differential pressure and relative pressure measurement															
Display, setting																
C	LCD display with backlighting (user optimised)															
L	Illuminated LCD display (reading optimised)															
Electrical output																
P1	1 switch output PNP															
P2	2 switch outputs PNP															
PU	1 switch output PNP and 0 ... 10 V analogue															
PI	1 switch output PNP and 4 ... 20 mA analogue															
2 ¹⁾	2 switch outputs PNP and 1 switch output 4 ... 20 mA analogue															
N1	1 switch output NPN															
N2	2 switch outputs NPN															
NU	1 switch output NPN and 0 ... 10 V analogue															
NI	1 switch output NPN and 4 ... 20 mA analogue															
Electrical connection																
M8	Plug M8x1															
M12	Plug M12x1															
Connecting cable																
SIM cable with straight connection socket																
G	2.5 m long															
G5	5 m long															
SIM cable with angled connection socket																
W	2.5 m long															
W5	5 m long															

1) Cannot be ordered via the modular product system

Pressure sensors SDE1, with display

Technical data

Function¹⁾

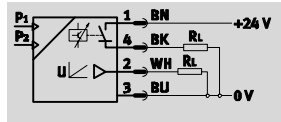

1) For example with 1 switch output PNP and 0 ... 10 V analogue

Voltage
15 ... 30 V DC

Pressure
-1 ... +10 bar

Temperature range
0 ... 50°C

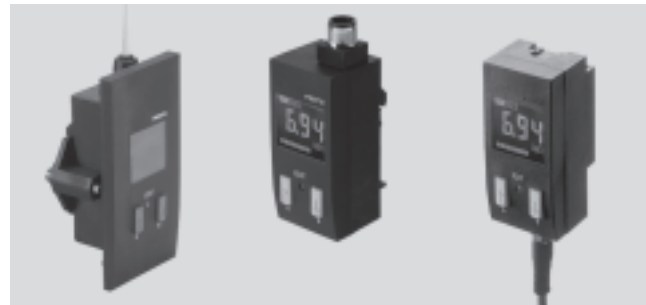

General technical data						
Pressure measuring range	[bar]	0 ... -1	-1 ... +1	0 ... 2	0 ... 6	0 ... 10
Mechanical						
Method of measurement	Piezoresistive pressure sensor with display					
Pneumatic connection	R ¹ / ₈ , R ¹ / ₄ , G ¹ / ₈ or QS-4					
Measured variable	Relative or differential pressure					
Accuracy	±2% of the measuring range final value					
Reproducibility of switching point	0.3%					
Electrical connection	Plug M8x1 or M12x1, round design to EN 60 947-5-2					
Type of mounting	Front panel mounting or on service unit, H-rail or adapter plate					
Mounting position	Any ¹⁾					
Electrical						
Operating voltage range	[V DC]	15 ... 30				
Max. output current	[mA]	150				
Protection against short circuit	Pulsed					
Protection against polarity reversal	For all electrical connections					
Switch output	PNP or NPN					
CE symbol	89/336/EEC (EMC)					

1) The collection of condensate in the sensor should be prevented.

Operating and environmental conditions						
Pressure measuring range	[bar]	0 ... -1	-1 ... +1	0 ... 2	0 ... 6	0 ... 10
Operating medium	Filtered compressed air, lubricated or unlubricated.					
Threshold value setting range	[bar]	-0.02 ... -0.998	-0.999 ... +0.996	0.04 ... 1.996	0.12 ... 5.99	0.2 ... 9.98
Hysteresis setting range	[bar]	0 ... -0.9	-0.9 ... +0.9	0 ... 1.8	0 ... 5.4	0 ... 9
Overload pressure	[bar]	5	5	6	16	20
Ambient temperature	[°C]	0 ... 50				
Temperature of medium	[°C]	0 ... 50				
Corrosion resistance class CRC ¹⁾	2					
Protection class to EN 60 529	IP 65					

1) Corrosion resistance class 2 according to Festo standard 940 070
Components requiring moderate corrosion resistance. Externally visible parts with primarily decorative surface requirements which are in direct contact with a normal industrial environment or media such as coolants or lubricating agents.

Weights [g]			
	Male thread R ¹ / ₈ or R ¹ / ₄	H-rail, wall or surface mounting	Front panel mounting
	95	70	150

Pressure sensors SDE1, with display

Technical data



Electrical outputs

Positive-switching (PNP)

P1

1 switch output PNP

Circuit symbol¹⁾

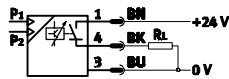

P2

2 switch outputs PNP

Circuit symbol¹⁾

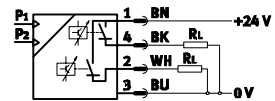

PU with plug M8

1 switch output PNP and 0 ... 10 V analogue

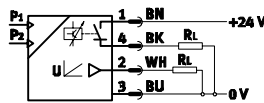

PU with plug M12

1 switch output PNP and 0 ... 10 V analogue

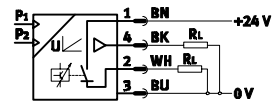

PI with plug M8

1 switch output PNP and 4 ... 20 mA analogue

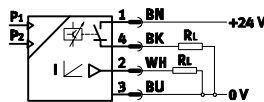

PI with plug M12

1 switch output PNP and 4 ... 20 mA analogue

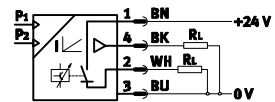

2I

2 switch outputs PNP and 1 switch output 4 ... 20 mA analogue

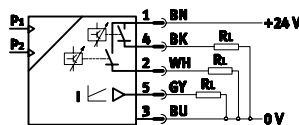

Negative-switching (NPN)

N1

1 switch output NPN

Circuit symbol¹⁾

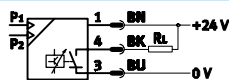

N2

2 switch outputs NPN

Circuit symbol¹⁾

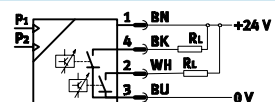

NU with plug M8

1 switch output NPN and 0 ... 10 V analogue

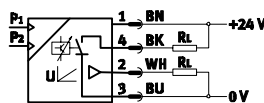

NU with plug M12

1 switch output NPN and 0 ... 10 V analogue

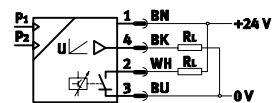

NI with plug M8

1 switch output NPN and 4 ... 20 mA analogue

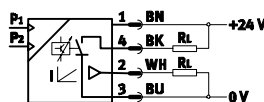

NI with plug M12

1 switch output NPN and 4 ... 20 mA analogue

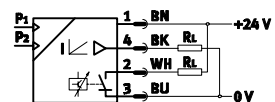

1) Core colours indicated apply when using plug sockets with cable SIM-...

Pressure sensors SDE1, with display

Technical data

Pin allocation

P1, N1 with plug M8



1 = +24 V
3 = 0 V
4 = Output A

P1, N1 with plug M12



1 = +24 V
3 = 0 V
4 = Output A

P2, N2, PI, NI, PU, NU with plug M8



1 = +24 V
2 = Output B (0 ... 10 V analogue)
3 = 0 V
4 = Output A

P2, N2, PI, NI, PU, NU with plug M12



1 = +24 V
2 = Output A
3 = 0 V
4 = Output B (0 ... 10 V analogue)

2I with plug M12



1 = +24 V
2 = Output B (0 ... 10 V analogue)
3 = 0 V
4 = Output A
5 = Output C (4 ... 20 mA analogue)

Materials

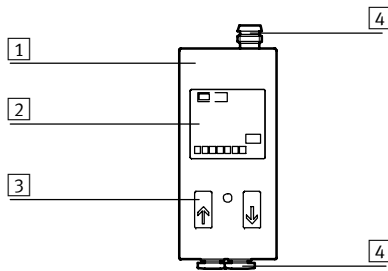

1	Housing	Polyacetate, reinforced
2	Display	Polycarbonate
3	Buttons	Nitrile rubber
4	Plug, QS push-in fittings	Brass, nickel plated or chrome plated
-	Pressure gauge adapter	Brass, nickel plated or chrome plated
-	Seals	Nitrile rubber
-	Clamping plate	Polyamide, fibreglass reinforced

Pressure sensors SDE1, with display

Technical data

Dimensions – Mounting using male thread R $\frac{1}{8}$ or R $\frac{1}{4}$

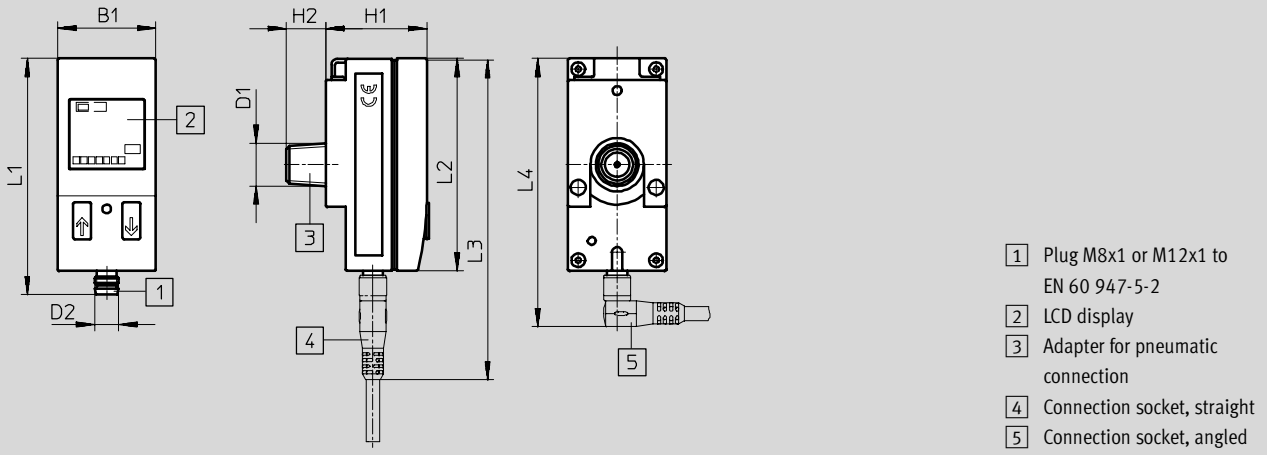

Type	B1	D1	D2	H1	H2	L1	L2	L3	L4
SDE1-...-R $\frac{1}{8}$ -M8	32.3	R $\frac{1}{8}$	M8	33	13	78	70	107	89
SDE1-...-R $\frac{1}{4}$ -M8		R $\frac{1}{4}$							
SDE1-...-R $\frac{1}{8}$ -M12	32.3	R $\frac{1}{8}$	M12	33	13	87	70	125	104
SDE1-...-R $\frac{1}{4}$ -M12		R $\frac{1}{4}$							

Dimensions – Front panel mounting

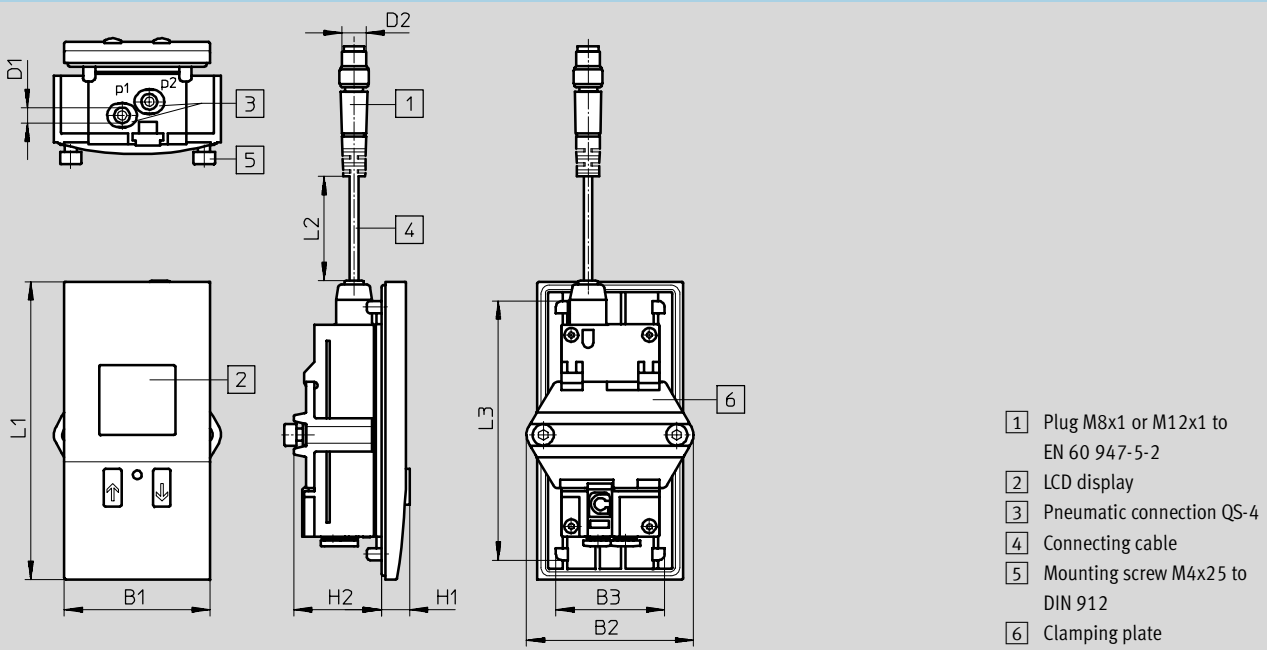

Type	B1	B2	B3	D1	D2	H1	H2	L1	L2	L3
SDE1-...-FQ4-M8	48	55	35.8	QS-4	M8x1	8.1	28.85	98	320	85.3
SDE1-...-FQ4-M12					M12x1					

Pressure sensors SDE1, with display

Technical data

Dimensions – H-rail, wall or surface mounting

Pneumatic connection G $\frac{1}{8}$

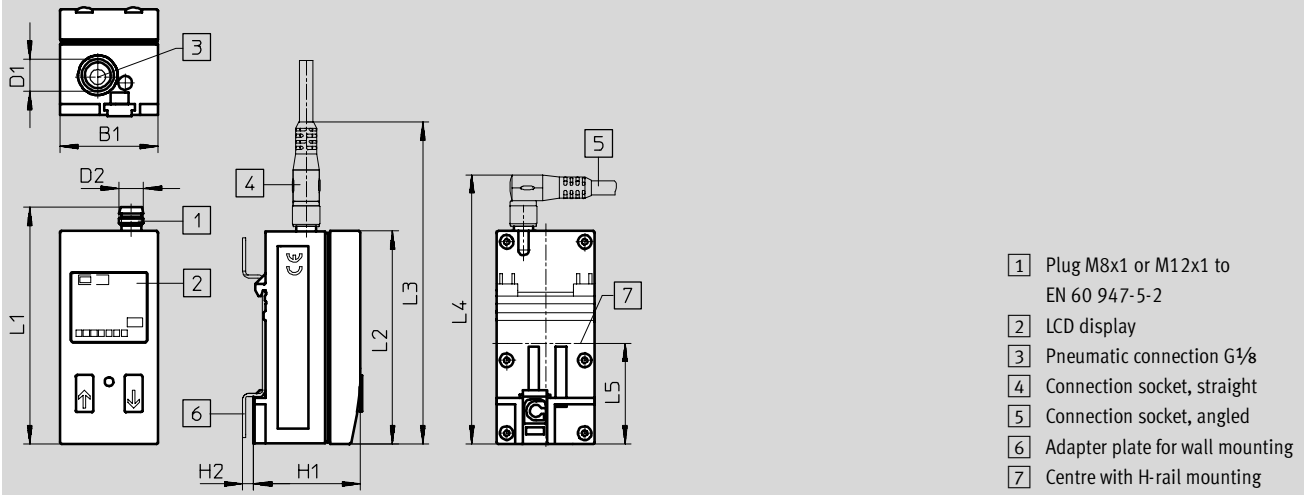

Type	B1	D1	D2	H1	H2	L1	L2	L3	L4	L5
SDE1-...-W18-...-M8	32.3	G $\frac{1}{8}$	M8	35.2	3.5	78	70	107	89	33
SDE1-...-H18-...-M8	32.3	G $\frac{1}{8}$	M8	35.2	3.5	78	70	107	89	33
SDE1-...-W18-...-M12	32.3	G $\frac{1}{8}$	M12	35.2	3.5	87	70	125	104	33
SDE1-...-H18-...-M12	32.3	G $\frac{1}{8}$	M12	35.2	3.5	87	70	125	104	33

Pneumatic connection QS-4

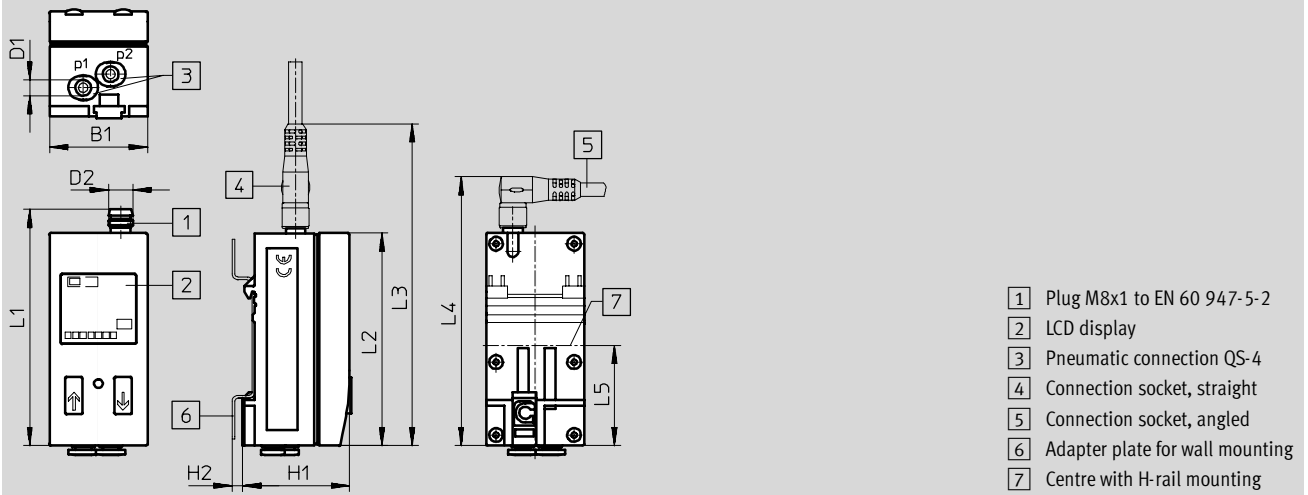

Type	B1	D1	D2	H1	H2	L1	L2	L3	L4	L5
SDE1-...-W18-...-M8	32.3	QS-4	M8	35.2	3.5	78	70	107	89	33
SDE1-...-H18-...-M8	32.3	QS-4	M8	35.2	3.5	78	70	107	89	33

Pressure sensors SDE1, with display

Technical data

FESTO

Ordering data – Pressure measuring range 0 ... –1 bar					
Electrical output	Display, setting		Electrical connection		Part No. Type ¹⁾
	LCD	Illuminated LCD	M8	M12	
Female thread G ¹ / ₈ , for H-rail mounting, relative pressure measurement					
1 switch output PNP	■	–	■	–	192 034 SDE1-V1-G2-H18-C-P1-M8
	–	■	■	–	529 973 SDE1-V1-G2-H18-L-P1-M8
2 switch outputs PNP	■	–	■	–	192 035 SDE1-V1-G2-H18-C-P2-M8
	–	■	■	–	529 974 SDE1-V1-G2-H18-L-P2-M8
1 switch output PNP and 0 ... 10 V analogue	■	–	■	–	529 959 SDE1-V1-G2-H18-C-PU-M8
	–	■	■	–	529 975 SDE1-V1-G2-H18-L-PU-M8
Female thread G ¹ / ₈ , for wall or surface mounting, relative pressure measurement ²⁾					
1 switch output PNP	–	■	–	■	534 065 SDE1-V1-G2-W18-L-P1-M12
1 switch output PNP and 4 ... 20 mA analogue	–	■	■	–	537 022 SDE1-V1-G2-W18-L-PI-M8
	–	■	–	■	537 023 SDE1-V1-G2-W18-L-PI-M12
Push-in fitting QS-4, for H-rail mounting, differential pressure and relative pressure measurement					
1 switch output PNP	■	–	■	–	192 036 SDE1-V1-G2-HQ4-C-P1-M8
	–	■	■	–	529 976 SDE1-V1-G2-HQ4-L-P1-M8
2 switch outputs PNP	■	–	■	–	192 037 SDE1-V1-G2-HQ4-C-P2-M8
	–	■	■	–	529 977 SDE1-V1-G2-HQ4-L-P2-M8
1 switch output PNP and 0 ... 10 V analogue	■	–	■	–	529 960 SDE1-V1-G2-HQ4-C-PU-M8
	–	■	■	–	529 978 SDE1-V1-G2-HQ4-L-PU-M8

Ordering data – Pressure measuring range 0 ... 2 bar					
Electrical output	Display, setting		Electrical connection		Part No. Type ¹⁾
	LCD	Illuminated LCD	M8	M12	
Female thread G ¹ / ₈ , for wall or surface mounting, relative pressure measurement ²⁾					
1 switch output PNP	–	■	■	–	537 024 SDE1-D2-G2-W18-L-P1-M8
2 switch outputs PNP	–	■	■	–	537 025 SDE1-D2-G2-W18-L-P2-M8
Push-in fitting QS-4, for H-rail mounting, differential pressure and relative pressure measurement					
2 switch outputs PNP	■	–	■	–	535 581 SDE1-D2-G2-HQ4-C-P2-M8

Ordering data – Pressure measuring range 0 ... 6 bar					
Electrical output	Display, setting		Electrical connection		Part No. Type ¹⁾
	LCD	Illuminated LCD	M8	M12	
Female thread G ¹ / ₈ , for wall or surface mounting, relative pressure measurement ²⁾					
1 switch output PNP	–	■	■	–	537 026 SDE1-D6-G2-W18-L-P1-M8
2 switch outputs PNP	–	■	■	–	537 027 SDE1-D6-G2-W18-L-P2-M8

1) Explanation of the order code → Type codes 4 / 8.2-84

2) Adapter plate SDE1-...-W... included in the scope of delivery

 **Note**
Additional variants and accessories can be configured and ordered via the SDE1 modular product system → 4 / 8.2-92.

Pressure sensors SDE1, with display

Technical data

Ordering data – Pressure measuring range 0 ... 10 bar						
Electrical output	Display		Electrical connection		Part No.	Type ¹⁾
	LCD	Illuminated LCD	M8	M12		
Male thread R1/8, mounting on service unit (MS or D series), relative pressure measurement						
1 switch output PNP	■	–	■	–	192 026	SDE1-D10-G2-R18-C-P1-M8
	–	■	■	–	529 970	SDE1-D10-G2-R18-L-P1-M8
	–	■	–	■	534 064	SDE1-D10-G2-R18-L-P1-M12
2 switch outputs PNP	■	–	■	–	192 027	SDE1-D10-G2-R18-C-P2-M8
	–	■	■	–	529 971	SDE1-D10-G2-R18-L-P2-M8
1 switch output PNP and 0 ... 10 V analogue	■	–	■	–	529 958	SDE1-D10-G2-R18-C-PU-M8
	–	■	■	–	529 972	SDE1-D10-G2-R18-L-PU-M8
Male thread R1/4, mounting on service unit (MS or D series), relative pressure measurement						
1 switch output PNP	■	–	■	–	192 028	SDE1-D10-G2-R14-C-P1-M8
	–	■	■	–	529 967	SDE1-D10-G2-R14-L-P1-M8
	–	■	–	■	534 157	SDE1-D10-G2-R14-L-P1-M12
2 switch outputs PNP	■	–	■	–	192 029	SDE1-D10-G2-R14-C-P2-M8
	–	■	■	–	529 968	SDE1-D10-G2-R14-L-P2-M8
1 switch output PNP and 0 ... 10 V analogue	■	–	■	–	529 957	SDE1-D10-G2-R14-C-PU-M8
	–	■	■	–	529 969	SDE1-D10-G2-R14-L-PU-M8
Female thread G1/8, for H-rail mounting, relative pressure measurement						
1 switch output PNP	■	–	■	–	192 030	SDE1-D10-G2-H18-C-P1-M8
	–	■	■	–	529 961	SDE1-D10-G2-H18-L-P1-M8
2 switch outputs PNP	■	–	■	–	192 031	SDE1-D10-G2-H18-C-P2-M8
	–	■	■	–	529 962	SDE1-D10-G2-H18-L-P2-M8
1 switch output PNP and 0 ... 10 V analogue	■	–	■	–	529 955	SDE1-D10-G2-H18-C-PU-M8
	–	■	■	–	529 963	SDE1-D10-G2-H18-L-PU-M8
Female thread G1/8, for wall or surface mounting, relative pressure measurement²⁾						
1 switch output PNP	–	■	–	■	534 063	SDE1-D10-G2-W18-L-P1-M12
1 switch output PNP and 0 ... 10 V analogue	–	■	■	–	530 900	SDE1-D10-G2-W18-L-PU-M8
2 switch outputs PNP and 1 switch output 4 ... 20 mA analogue	–	■	–	■	534 062	SDE1-D10-G2-W18-L-2I-M12
1 switch output PNP and 4 ... 20 mA analogue	–	■	■	–	537 020	SDE1-D10-G2-W18-L-PI-M8
	–	■	–	■	537 021	SDE1-D10-G2-W18-L-PI-M12
Push-in fitting QS-4, for H-rail mounting, differential pressure and relative pressure measurement						
1 switch output PNP	■	–	■	–	197 032	SDE1-D10-G2-HQ4-C-P1-M8
	–	■	■	–	529 964	SDE1-D10-G2-HQ4-L-P1-M8
2 switch outputs PNP	■	–	■	–	197 033	SDE1-D10-G2-HQ4-C-P2-M8
	–	■	■	–	529 965	SDE1-D10-G2-HQ4-L-P2-M8
1 switch output PNP and 0 ... 10 V analogue	■	–	■	–	529 956	SDE1-D10-G2-HQ4-C-PU-M8
	–	■	■	–	529 966	SDE1-D10-G2-HQ4-L-PU-M8
Push-in fitting QS-4, for front panel mounting, differential pressure and relative pressure measurement						
1 switch output PNP	–	■	■	–	537 028	SDE1-D10-G2-FQ4-L-P1-M8
	–	■	–	■	537 029	SDE1-D10-G2-FQ4-L-P1-M12
2 switch outputs PNP	–	■	■	–	537 030	SDE1-D10-G2-FQ4-L-P2-M8
	–	■	–	■	537 031	SDE1-D10-G2-FQ4-L-P2-M12

1) Explanation of the order code → Type codes 4 / 8.2-84

2) Adapter plate SDE1-...-W... included in the scope of delivery

Pressure sensors SDE1

Ordering data – Modular products

[M] Mandatory data								[O] Options
Module No.	Function	Pressure measuring range	Accuracy	Pneumatic connection and assembly	Display and adjustment	Electrical output	Electrical connection	Accessories: Plug socket
192 766	SDE1	B2 V1 D2 D6 D10	G2	R18 R14 H18 W18 HQ4 WQ4 FQ4	C L	P1 P2 PU PI N1 N2 NU NI	M8 M12	G W G5 W5
Ordering example								
192 766	SDE1	- D6	- G2	- W18	- L	- P2	- M12	- W5

Ordering table		Condi-tions	Code	Enter code
[M] Module No.	192 766			
Function	Pressure sensor		SDE1	SDE1
Pressure measuring range	Pressure measuring range -1 ... 1 bar		-B2	
	Pressure measuring range 0 ... -1 bar		-V1	
	Pressure measuring range 0 ... 2 bar		-D2	
	Pressure measuring range 0 ... 6 bar		-D6	
	Pressure measuring range 0 ... 10 bar		-D10	
Accuracy	Accuracy 2%		-G2	-G2
Pneumatic connection and assembly	Connection R $\frac{1}{8}$ (for D series)		-R18	
	Connection R $\frac{1}{4}$ (for D series)		-R14	
	Relative pressure with G $\frac{1}{8}$ connection for H-rail mounting		-H18	
	Relative pressure with G $\frac{1}{8}$ connection for wall or surface mounting		-W18	
	Differential pressure, 4 mm push-in fitting for H-rail mounting		-HQ4	
	Differential pressure, 4 mm push-in fitting for wall or surface mounting		-WQ4	
	Front panel mounting, 4 mm push-in fitting		-FQ4	
Display and adjustment	LCD display (user optimised)		-C	
	Illuminated LCD (reading optimised)		-L	
Electrical output	1 switch output PNP		-P1	
	2 switch outputs PNP		-P2	
	2 switch outputs PNP, 1 analogue output 0 ... 10 V analogue		-PU	
	1 switch output PNP, 1 analogue output 4 ... 20 mA		-PI	
	1 switch output NPN		-N1	
	2 switch outputs NPN		-N2	
	1 switch output NPN, 1 analogue output 0 ... 10 V		-NU	
	1 switch output NPN, 1 analogue output 4 ... 20 mA		-NI	
Electrical connection	Plug M8		-M8	
	Plug M12		-M12	
[O] Accessories			-	-
Plug socket	Connecting cable, straight socket, 2.5 m		G	
	Connecting cable, angled socket, 2.5 m		W	
	Connecting cable, straight socket, 5 m		G5	
	Connecting cable, angled socket, 5 m		W5	

Transfer order code

192 766	SDE1	-		-	G2	-		-		-		-	
---------	------	---	--	---	----	---	--	---	--	---	--	---	--

Pressure sensors SDE1, with display

Accessories



Adapter plate SDE1-...-W...
for wall or surface mounting

Material:
Steel

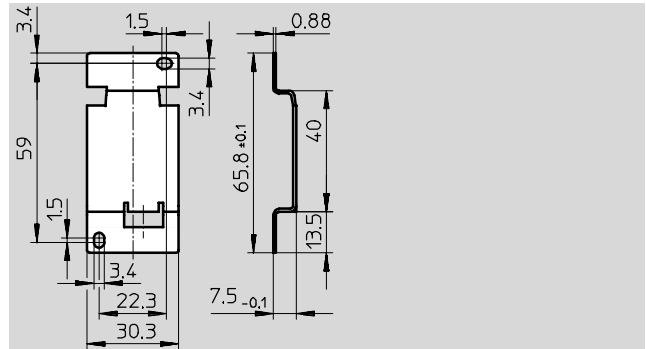

Ordering data		Part No.	Type
Adapter plate ¹⁾		194 297	SDE1-...-W...

1) Included in the scope of delivery with SDE1-...-W...

Safety guard SDE1-SH

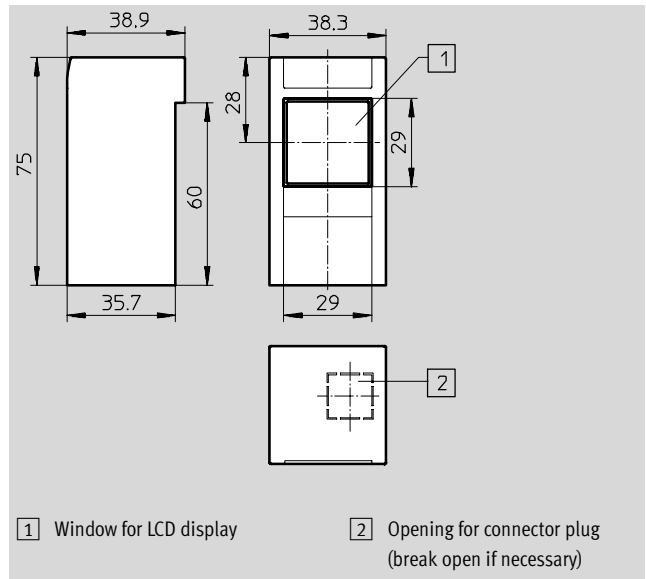

Material:
Polyphenylene sulphide, reinforced





Ordering data		Part No.	Type
Safety guard		537 074	SDE1-SH

Pressure sensors SDE1, with display

Accessories

Ordering data – Plug sockets with cable M8x1							Technical data → 4 / 8.3-9	
	Assembly	Connection	Switch output		Cable length [m]	Part No.	Type	
			PNP	NPN				
Straight socket								
	Union nut M8x1	3-pin	■	■	2.5	159 420	SIM-M8-3GD-2,5-PU	
			■	■	5	159 421	SIM-M8-3GD-5-PU	
	4-pin	■	■	2.5	158 960	SIM-M8-4GD-2,5-PU		
		■	■	5	158 961	SIM-M8-4GD-5-PU		
Angled socket								
	Union nut M8x1	3-pin	■	■	2.5	159 422	SIM-M8-3WD-2,5-PU	
			■	■	5	159 423	SIM-M8-3WD-5-PU	
	4-pin	■	■	2.5	158 962	SIM-M8-4WD-2,5-PU		
		■	■	5	158 963	SIM-M8-4WD-5-PU		

Ordering data – Plug sockets with cable M12x1							Technical data → 4 / 8.3-12	
	Assembly	Connection	Switch output		Cable length [m]	Part No.	Type	
			PNP	NPN				
Straight socket								
	Union nut M12x1	3-pin	■	■	2.5	159 428	SIM-M12-3GD-2,5-PU	
			■	■	5	159 429	SIM-M12-3GD-5-PU	
	4-pin	■	■	5	164 259	SIM-M12-4GD-5-PU		
		5-pin	■	■	2.5	175 715	SIM-M12-5GD-2,5-PU	
			■	■	5	175 716	SIM-M12-5GD-5-PU	
Angled socket								
	Union nut M12x1	3-pin	■	■	2.5	159 430	SIM-M12-3WD-2,5-PU	
			■	■	5	159 431	SIM-M12-3WD-5-PU	
	4-pin	■	■	5	164 258	SIM-M12-4WD-5-PU		

 Core Range