









- 3 thread types – M, R, and G thread
- 360° rotatable
- R-threads can be re-used up to five times.

# Self-closing/rotary push-in fittings QS, Quick Star

Key features



Application	Simply "plug and work"	Reliably connected	Captive seal
 <p>Effortless selection of the right fitting. Quick Star offers a secure solution for every connection. The convenient push-in fitting system includes well over 1000 types of standard and function fittings.</p>	 <p>The stainless steel retaining ring within the fitting holds the tubing securely without damaging its surface. Vibration and pressure surges are safely absorbed. The tubing can be detached easily by pressing down the blue release ring. For your convenience, the appropriate outside tubing diameter is marked on the release ring.</p>	 <p>A nitrile rubber sealing ring guarantees a perfect seal between standard OD tubing and the body of the fitting. Standard tubing is suitable for use with compressed air and vacuum.</p>	 <p>All of the brass components included in Festo's push-in fittings are nickel plated and are thus highly resistant to corrosion. The tapered ISO R threads have a self-sealing PTFE coating, which allows the fitting to be re-used up to five times without the need for additional sealing components.</p>

360° rotatable	360° rotatable, with ball bearing
 <p>Alignment is performed during assembly. Tube movement is compensated during use.</p>	 <p>Permits rotating motion of up to 500 rpm during use.</p>

## Which fitting fits which thread?

### Metric thread

- Cylindrical metric thread is comparable with G-thread
- Sealing is guaranteed by a clip-on O-ring

### G thread

- to DIN ISO 228-1
- Shorter thread
  - Constant installation depth
  - Replaceable sealing ring
  - Sealing at front
  - Can be re-used a number of times thanks to replaceable sealing ring

### R thread

- to DIN 2999-1 und ISO 7/1
- Self-sealing thread
  - Sealing on the threads
  - No additional sealing surface required
  - Smaller installation dimensions since there is no need for a rebate for the sealing surface
  - Can be re-used up to five times

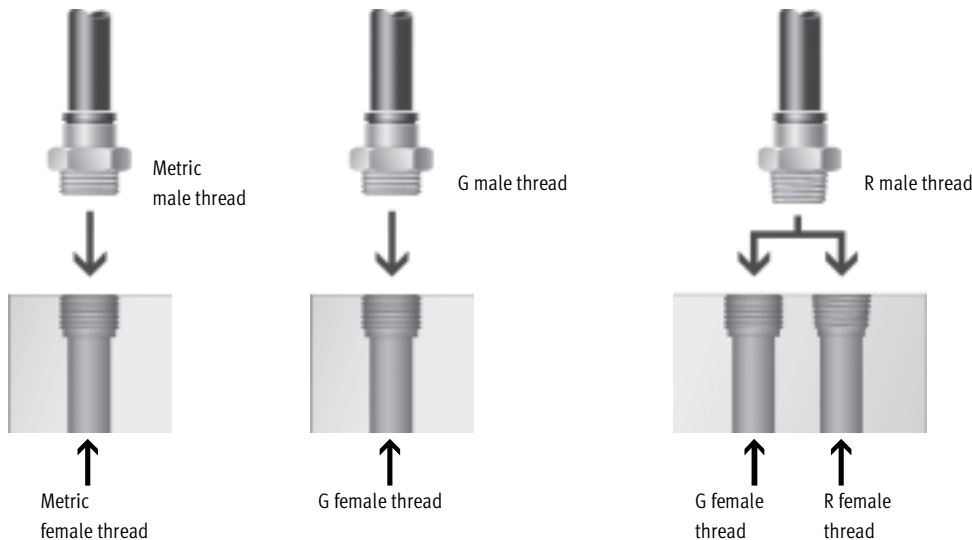

# Self-closing/rotary push-in fittings QS, Quick Star

Technical data

Materials		
Sectional view		
	Standard QS	
	1 Release ring	Polycarbonate
	2 Flexible sleeve	Nitrile rubber
	3 Housing	Steel Polybuteneterephthalate Nickel plated brass Anodised aluminium
	4 Tube clamping segment	Brass Stainless steel
	5 Threaded coupling	Nickel plated brass PTFE sealing compound
	6 Plastic tubing, standard O.D.	PAN PUN PUN-H PUN-E

Tubing insertion depth						
	Tubing O.D. [mm]	4	6	8	10	12
	Standard QS		15	17	18	21

Operating and environmental conditions		
	Standard QSK	Standard QSR
Operating pressure [bar]	0 ... +10	-0.95 ... +10
Operating temperature [°C]	0 ... 60	
Corrosion resistance CRC <sup>1)</sup>	1	







1) Corrosion resistance class 1 according to Festo standard 940 070  
Components requiring low corrosion resistance. Transport and storage protection. Parts that do not have primarily decorative surface requirements, e.g. in internal areas that are not visible or behind covers.

Possible push-in fitting/tubing combinations					
Thread	Tubing O.D. [mm]				
	4	6	8	10	12
M5	■		-	-	-
R1/8		■			-
R1/4			■		
R3/8	-			■	
R1/2	-	-	-		■
G1/8		■		-	-
G1/4	-		■		
G3/8	-	-		■	
G1/2	-	-	-	-	■

Possible thread/tubing O.D. combinations  
 Optimum thread/tubing O.D. combinations (with regard to flow)

# Self-closing/rotary push-in fittings QS, Quick Star

Product range overview

Shape	Design	Type	Connection D1				Connection D2		→ Page
			M thread	R thread	G thread	Tubing O.D.	Tubing O.D.		
Straight	<b>Self-closing push-in fitting – Male thread with external hex</b>								
		QSK	M5	–	–	–	4, 6	–	3 / 5.6-5
			–	R1/8	G1/8		4, 6, 8		
			–	R1/4	G1/4		6, 8, 10		
			–	R3/8	G3/8		8, 10, 12		
			–	R1/2	G1/2		12		
	<b>Self-closing push-in connector</b>								
		QSK	–	–	–	4	–	–	3 / 5.6-6
			–	–	–	6			
			–	–	–	8			
			–	–	–	10			
			–	–	–	12			
	<b>Push-in bulkhead connector</b>								
		QSSK	–	–	–	4	–	–	3 / 5.6-7
			–	–	–	6			
–			–	–	8				
–			–	–	10				
–			–	–	12				
<b>Rotary push-in fitting, rotatable 360° via ball bearing – Male thread with external hex</b>									
	QSR	M5	–	–	–	4, 6	–	3 / 5.6-10	
		–	R1/8	G1/8		4, 6, 8			
		–	R1/4	G1/4		6, 8			
		–	R3/8	G3/8		8, 10, 12			
		–	R1/2	G1/2		12			
L-shape	<b>Self-closing push-in L-fitting – can be turned 360° – Male thread with external hex</b>								
		QSKL	M5	–	–	–	4, 6	–	3 / 5.6-8
			–	R1/8	G1/8		4, 6, 8		
			–	R1/4	G1/4		6, 8, 10		
			–	R3/8	G3/8		8, 10, 12		
			–	R1/2	G1/2		12		
	<b>Rotary push-in L-fitting, rotatable 360° via ball bearing – Male thread with external hex</b>								
		QSRL	M5	–	–	–	4, 6	–	3 / 5.6-9
			–	R1/8	G1/8		4, 6, 8		
			–	R1/4	G1/4		6, 8		
–			R3/8	G3/8	8, 10, 12				
–			R1/2	G1/2	12				

# Self-closing push-in fittings QSK, Quick Star

Technical data

## Self-closing push-in fitting QSK

Male thread  
with external hex



M thread

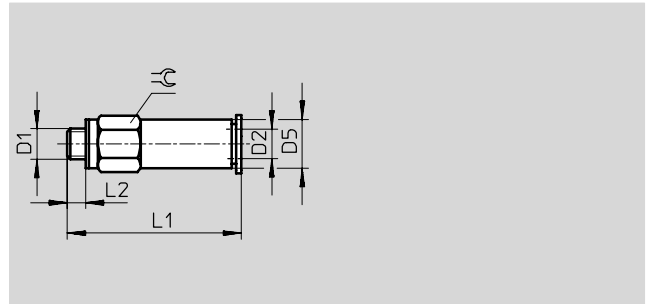

R thread

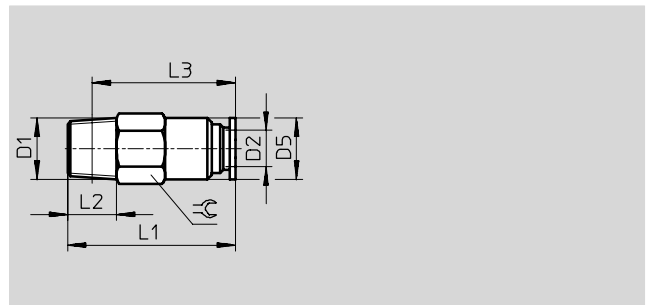

Dimensions and ordering data										
Connection	Nominal size	Tubing O.D.	D5 ∅	L1	L2	L3	⌀	Part No.	Type	PU*
D1	[mm]	D2								
Metric thread with sealing ring										
M5	1.6	4	8	28.5	3.5	-	8	153 291	QSK-M5-4	1
	2.3	6	10	32	3.5	-	10	153 292	QSK-M5-6	1
R thread										
R1/8	1.6	4	9	25.5	8	20	10	153 419	QSK-1/8-4	1
	3	6	10	27.5	8	23	10	153 420	QSK-1/8-6	1
	3.4	8	14	36	8	32	14	153 422	QSK-1/8-8	1
R1/4	3	6	12	27.5	11	21	14	153 421	QSK-1/4-6	1
	4.2	8	14	36	11	30	14	153 423	QSK-1/4-8	1
	4.8	10	17	38.5	11	32.5	17	153 425	QSK-1/4-10	1
R3/8	4.5	8	15	36	12	29.5	17	153 424	QSK-3/8-8	1
	5.6	10	17	40	12	33.5	17	153 426	QSK-3/8-10	1
	6	12	21	46	12	39.5	21	153 427	QSK-3/8-12	1
R1/2	6.3	12	21	46	15	38	21	153 428	QSK-1/2-12	1

\* Packaging unit quantity

Core Range

# Self-closing push-in fittings QSK, Quick Star

Technical data



## Self-closing push-in fitting QSK

Male thread with external hex



G thread

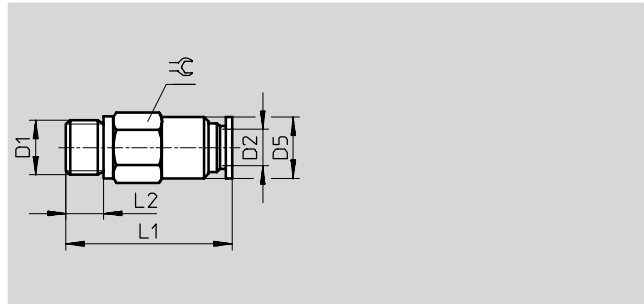

### Dimensions and ordering data

Connection	Nominal size	Tubing O.D.	D5	L1	L2	⌀	Part No.	Type	PU*
D1	[mm]	D2	∅						
G thread with sealing ring									
G <sup>1</sup> / <sub>8</sub>	1.6	4	8.8	23	4.6	13	186 294	QSK-G <sup>1</sup> / <sub>8</sub> -4	1
	3	6	10	25.7	4.6	13	186 295	QSK-G <sup>1</sup> / <sub>8</sub> -6	1
	3.4	8	14	34.2	4.6	14	186 297	QSK-G <sup>1</sup> / <sub>8</sub> -8	1
G <sup>1</sup> / <sub>4</sub>	3	6	12	24.7	6.6	17	186 296	QSK-G <sup>1</sup> / <sub>4</sub> -6	1
	4.2	8	14	34.5	6.6	17	186 298	QSK-G <sup>1</sup> / <sub>4</sub> -8	1
	4.8	10	17	36.8	6.6	17	186 300	QSK-G <sup>1</sup> / <sub>4</sub> -10	1
G <sup>3</sup> / <sub>8</sub>	4.5	8	15	34.5	8.1	19	186 299	QSK-G <sup>3</sup> / <sub>8</sub> -8	1
	5.6	10	17	38.3	8.1	19	186 301	QSK-G <sup>3</sup> / <sub>8</sub> -10	1
	6	12	20.8	44.3	8.1	21	186 302	QSK-G <sup>3</sup> / <sub>8</sub> -12	1
G <sup>1</sup> / <sub>2</sub>	6.3	12	20.8	44.4	11.1	24	186 303	QSK-G <sup>1</sup> / <sub>2</sub> -12	1

\* Packaging unit quantity

## Self-closing push-in fittings QSK/QSSK, Quick Star

Technical data

### Self-closing push-in connector QSK

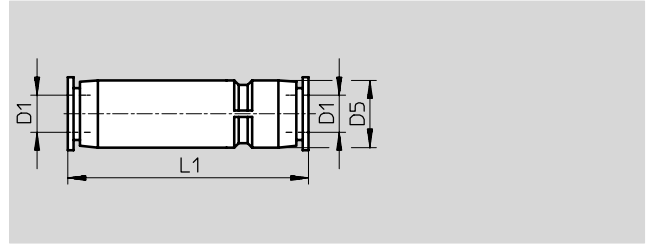





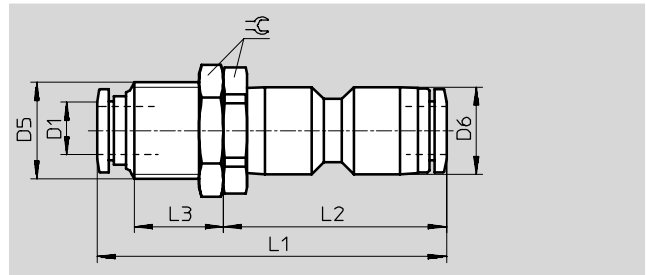

Dimensions and ordering data							
Tubing O.D. D1	Nominal size [mm]	D5 Ø	L1	Weight/piece [g]	Part No.	Type	PU*
4	1.6	8.5	36	3.5	153 439	QSK-4	1
6	3	11	39.5	6	153 440	QSK-6	1
8	4.5	14.5	54.5	16	153 441	QSK-8	1
10	5.3	17.5	60.5	26	153 442	QSK-10	1
12	6.2	21	70.5	40.5	153 443	QSK-12	1

\* Packaging unit quantity

### Push-in bulkhead connector QSSK



Dimensions and ordering data												
Tubing O.D. D1	Nominal size [mm]	D5 Ø	D6 Ø	L1	L2	L3		Weight/piece [g]	Part No.	Type		PU*
4	2.6	M10x1	10	43.1	29.6	10	12	14	130 637	QSSK-4	 New	10
6	4	M12x1	12.5	47.6	34.2	9.9	14	20	130 638	QSSK-6	 New	10
8	5.7	M16x1	14.5	58.1	37.1	14.7	19	38	130 639	QSSK-8	 New	10
10	7	M20x1	17.5	66.5	43.4	16.2	24	68	130 640	QSSK-10	 New	1
12	8	M22x1	21	75.5	48.6	20.7	27	98	130 641	QSSK-12	 New	1

\* Packaging unit quantity

# Self-closing push-in fittings QSKL, Quick Star

Technical data



## Self-closing push-in L-fitting QSKL

360° rotatable  
Male thread  
with external hex

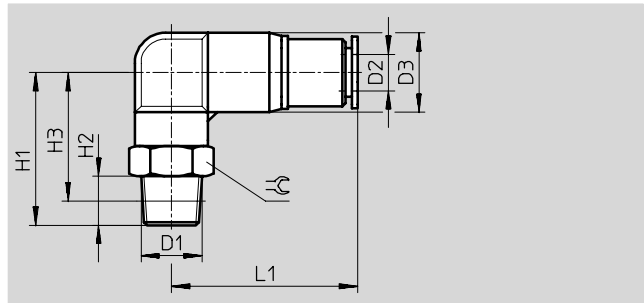
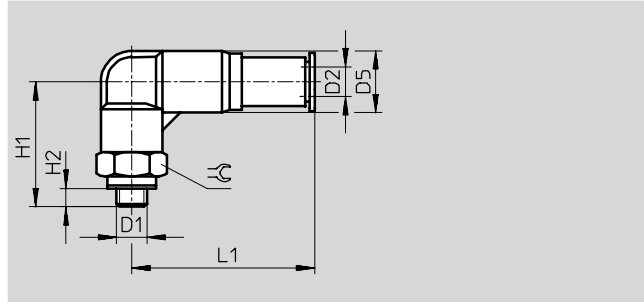

Dimensions and ordering data												
Connection	Nominal size	Tubing O.D.	D5 ∅	H1	H2	H3	L1	⌀	Weight/ piece [g]	Part No.	Type	PU*
D1	[mm]	D2										
Metric thread with sealing ring												
M5	1.5	4	10	20.5	3.5	–	30	10	–	153 294	QSKL-M5-4	1
	2.3	6	12.5	22	3.5	–	30.5	12	–	153 295	QSKL-M5-6	1
R thread												
R $\frac{1}{8}$	1.5	4	10	23.5	8	19.5	30.5	10	17	153 429	QSKL- $\frac{1}{8}$ -4	1
	3	6	12.5	25	8	21	30.5	12	22	153 430	QSKL- $\frac{1}{8}$ -6	1
	4.2	8	14.5	28	8	24	43	14	34	153 432	QSKL- $\frac{1}{8}$ -8	1
R $\frac{1}{4}$	3.2	6	12.5	28	11	22	30.5	14	29.5	153 431	QSKL- $\frac{1}{4}$ -6	1
	4	8	14.5	31	11	25	43	14	40	153 433	QSKL- $\frac{1}{4}$ -8	1
	5.2	10	17.5	36	11	30	49.5	17	58.5	153 435	QSKL- $\frac{1}{4}$ -10	1
R $\frac{3}{8}$	4.3	8	14.5	33	12	26.5	43	17	53	153 434	QSKL- $\frac{3}{8}$ -8	1
	5.2	10	17.5	37	12	30.5	49.5	17	67	153 436	QSKL- $\frac{3}{8}$ -10	1
	6.2	12	21	39	12	32.5	57.5	21	92.5	153 437	QSKL- $\frac{3}{8}$ -12	1
R $\frac{1}{2}$	6.2	12	21	42	15	34	57.5	21	107	153 438	QSKL- $\frac{1}{2}$ -12	1

\* Packaging unit quantity



# Self-closing push-in fittings QSKL, Quick Star



Technical data

## Self-closing push-in L-fitting QSKL-...

360° rotatable  
Male thread  
with external hex



G thread

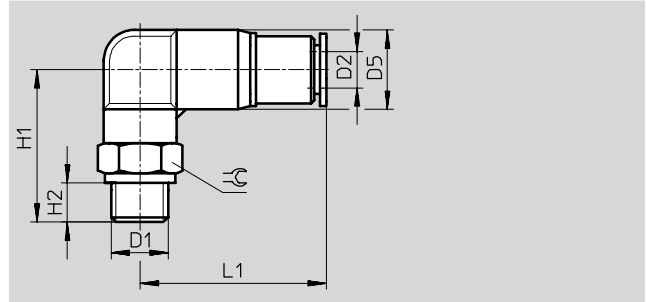

Dimensions and ordering data										
Connection	Nominal size	Tubing O.D.	D5	H1	H2	L1	⌀	Part No.	Type	PU*
D1	[mm]	D2	∅							
G thread with sealing ring										
G <sup>1</sup> / <sub>8</sub>	1.5	4	10	22.8	4.6	30.3	13	186 304	QSKL-G <sup>1</sup> / <sub>8</sub> -4	1
	3	6	12.5	23.5	4.6	30.4	13	186 305	QSKL-G <sup>1</sup> / <sub>8</sub> -6	1
	4.2	8	14.5	26.5	4.6	43	14	186 307	QSKL-G <sup>1</sup> / <sub>8</sub> -8	1
G <sup>1</sup> / <sub>4</sub>	3.2	6	12.5	26.5	6.6	30.4	17	186 306	QSKL-G <sup>1</sup> / <sub>4</sub> -6	1
	4	8	14.5	29.5	6.6	43	17	186 308	QSKL-G <sup>1</sup> / <sub>4</sub> -8	1
	5.2	10	17.5	33.5	6.6	49.3	17	186 310	QSKL-G <sup>1</sup> / <sub>4</sub> -10	1
G <sup>3</sup> / <sub>8</sub>	4.3	8	14.5	31.5	8.1	43	19	186 309	QSKL-G <sup>3</sup> / <sub>8</sub> -8	1
	5.2	10	17.5	35.5	8.1	49.3	19	186 311	QSKL-G <sup>3</sup> / <sub>8</sub> -10	1
	6.2	12	21	37.5	8.1	57.1	21	186 312	QSKL-G <sup>3</sup> / <sub>8</sub> -12	1
G <sup>1</sup> / <sub>2</sub>	6.2	12	21	42.5	11.1	57.1	22	186 313	QSKL-G <sup>1</sup> / <sub>2</sub> -12	1

\* Packaging unit quantity

# Rotary push-in fittings QSR, Quick Star

Technical data



## Rotary push-in fitting QSR

Rotatable 360°  
via ball bearing  
Male thread with  
external hex



M thread

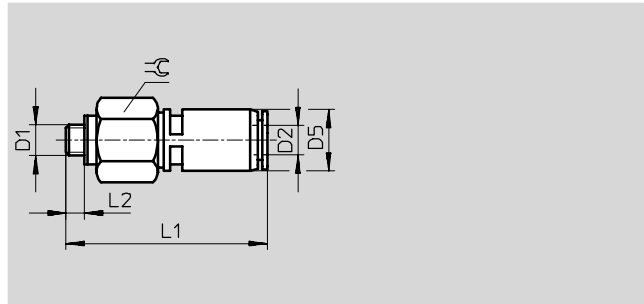

R thread

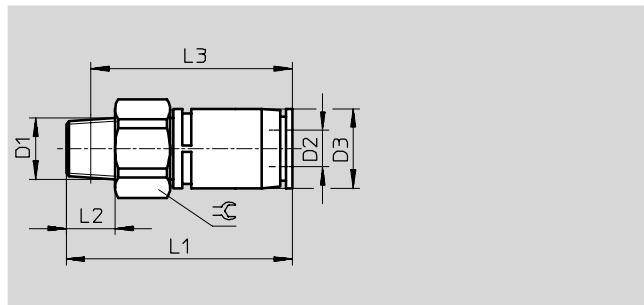

Dimensions and ordering data												
Connection	Nominal size	Tubing O.D.	Rotational speed	D5	L1	L2	L3	⌀	Weight/ piece	Part No.	Type	PU*
D1	[mm]	D2	[rpm]	∅					[g]			
Metric thread with sealing ring												
M5	1.9	4	500	10.5	33	3.5	-	12	-	153 526	QSR-M5-4	1
	2.3	6	500	13	36.5	3.5	-	14	-	153 527	QSR-M5-6	1
R thread												
R1/8	2.5	4	500	10.5	34.5	8	30.5	12	14	153 401	QSR-1/8-4	1
	4	6	500	13	37	8	33	14	17	153 402	QSR-1/8-6	1
	6	8	400	15	46	8	42	17	32	153 404	QSR-1/8-8	1
R1/4	4	6	500	13	39	11	33	14	23	153 403	QSR-1/4-6	1
	6	8	400	15	45	11	39	17	31	153 405	QSR-1/4-8	1
R3/8	6	8	400	15	45	12	38.5	17	38	153 406	QSR-3/8-8	1
	8	10	300	18	56.5	12	50	22	65	153 407	QSR-3/8-10	1
	9.5	12	250	21	62.5	12	56	24	95	153 408	QSR-3/8-12	1
R1/2	9.5	12	250	21	62.5	15	54.5	24	101	153 409	QSR-1/2-12	1

\* Packaging unit quantity

# Rotary push-in fittings QSR, Quick Star

Technical data



## Rotary push-in fitting QSR

Rotatable 360°  
via ball bearing  
for plastic tubing  
with standard O.D.



G thread

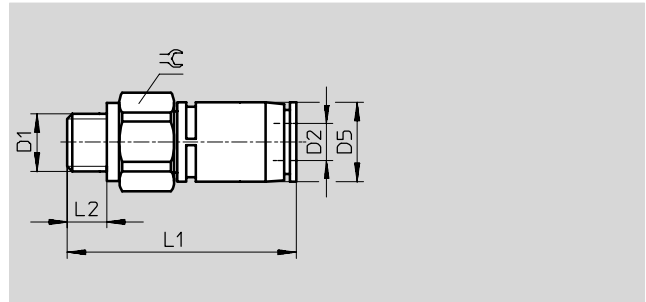

Dimensions and ordering data										
Connection	Nominal size	Tubing O.D.	Rotational speed	D5	L1	L2	⌀	Part No.	Type	PU*
D1	[mm]	D2	[rpm]	∅						
G thread with sealing ring										
G <sup>1</sup> / <sub>8</sub>	2.5	4	500	10	32.6	4.6	13	<b>186 276</b>	<b>QSR-G<sup>1</sup>/<sub>8</sub>-4</b>	<b>1</b>
	4	6	500	12.5	35.4	4.6	14	<b>186 277</b>	<b>QSR-G<sup>1</sup>/<sub>8</sub>-6</b>	<b>1</b>
	6	8	400	14.5	43.8	4.6	17	<b>186 279</b>	<b>QSR-G<sup>1</sup>/<sub>8</sub>-8</b>	<b>1</b>
G <sup>1</sup> / <sub>4</sub>	4	6	500	12.5	36.4	6.6	17	<b>186 278</b>	<b>QSR-G<sup>1</sup>/<sub>4</sub>-6</b>	<b>1</b>
	6	8	400	14.5	41.8	6.6	17	<b>186 280</b>	<b>QSR-G<sup>1</sup>/<sub>4</sub>-8</b>	<b>1</b>
G <sup>3</sup> / <sub>8</sub>	6	8	400	14.5	42.8	8.1	19	<b>186 281</b>	<b>QSR-G<sup>3</sup>/<sub>8</sub>-8</b>	<b>1</b>
	8	10	300	17.8	55.3	8.1	22	<b>186 282</b>	<b>QSR-G<sup>3</sup>/<sub>8</sub>-10</b>	<b>1</b>
	9.5	12	200	20.8	60.8	8.1	24	<b>186 283</b>	<b>QSR-G<sup>3</sup>/<sub>8</sub>-12</b>	<b>1</b>
G <sup>1</sup> / <sub>2</sub>	9.5	12	200	20.8	60.8	11.1	24	<b>186 284</b>	<b>QSR-G<sup>1</sup>/<sub>2</sub>-12</b>	<b>1</b>

\* Packaging unit quantity

# Rotary push-in fittings QSRL, Quick Star

Technical data



## Rotary push-in L-fitting QSRL

Rotatable 360°  
via ball bearing  
Male thread  
with external hex



M thread

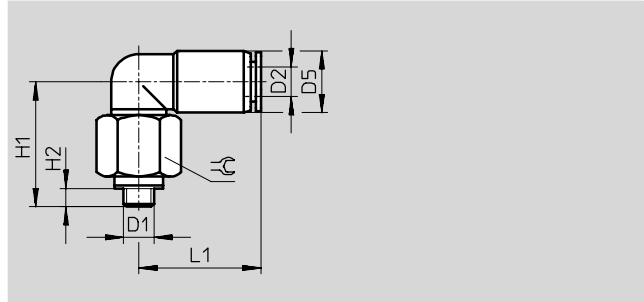

R thread

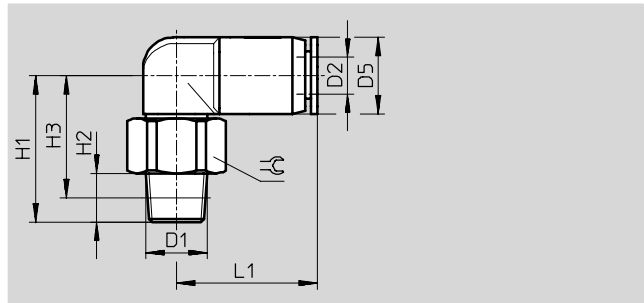

Dimensions and ordering data												
Connection	Nominal size	Tubing O.D.	Rotational speed	D5	H1	H2	H3	L1	⌀	Part No.	Type	PU*
D1	[mm]	D2	[rpm]	∅								
Metric thread with sealing ring												
M5	1.5	4	500	10.5	20.5	3.5	-	20	12	153 529	QSRL-M5-4	1
	1.9	6	500	13	23.5	3.5	-	23	14	153 530	QSRL-M5-6	1
R thread												
R1/8	2.5	4	500	10	23	8	18	20	12	153 410	QSRL-1/8-4	1
	4	6	500	12.5	24	8	20	23	14	153 411	QSRL-1/8-6	1
	6	8	400	14.5	31.5	8	27.5	26	14	153 413	QSRL-1/8-8	1
R1/4	4	6	500	12.5	26	11	20	23	14	153 412	QSRL-1/4-6	1
	6	8	400	14.5	30.5	11	24.5	26	17	153 414	QSRL-1/4-8	1
R3/8	6	8	400	14.5	30.5	12	24	26	17	153 415	QSRL-3/8-8	1
	8	10	300	17.5	36	12	29.5	30	22	153 416	QSRL-3/8-10	1
	9.5	12	250	21	41.5	12	35	33	24	153 417	QSRL-3/8-12	1
R1/2	9.5	12	250	21	41.5	15	33.5	33	24	153 418	QSRL-1/2-12	1

\* Packaging unit quantity

# Rotary push-in fittings QSRL, Quick Star

Technical data



## Rotary push-in L-fitting QSRL

Rotatable 360°  
via ball bearing  
Male thread  
with external hex



G thread

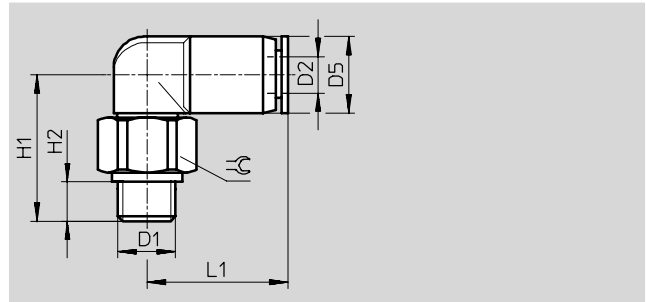

Dimensions and ordering data											
Connection	Nominal size	Tubing O.D.	Rotational speed	D5	H1	H2	L1	≅	Part No.	Type	PU*
D1	[mm]	D2	[rpm]	∅							
G thread with sealing ring											
G <sup>1</sup> / <sub>8</sub>	1.5	4	500	10	20.5	4.6	19.7	13	<b>186 285</b>	<b>QSRL-G<sup>1</sup>/<sub>8</sub>-4</b>	<b>1</b>
	3	6	500	12.5	22.4	4.6	22.8	14	<b>186 286</b>	<b>QSRL-G<sup>1</sup>/<sub>8</sub>-6</b>	<b>1</b>
	4.2	8	400	14.5	30	4.6	25.7	17	<b>186 288</b>	<b>QSRL-G<sup>1</sup>/<sub>8</sub>-8</b>	<b>1</b>
G <sup>1</sup> / <sub>4</sub>	3.2	6	500	12.5	23.5	6.6	22.8	17	<b>186 287</b>	<b>QSRL-G<sup>1</sup>/<sub>4</sub>-6</b>	<b>1</b>
	4	8	400	14.5	28	6.6	25.7	17	<b>186 289</b>	<b>QSRL-G<sup>1</sup>/<sub>4</sub>-8</b>	<b>1</b>
G <sup>3</sup> / <sub>8</sub>	4.3	8	400	14.5	29	8.1	25.7	19	<b>186 290</b>	<b>QSRL-G<sup>3</sup>/<sub>8</sub>-8</b>	<b>1</b>
	5.2	10	300	17.5	34.7	8.1	29.5	22	<b>186 291</b>	<b>QSRL-G<sup>3</sup>/<sub>8</sub>-10</b>	<b>1</b>
	6.2	12	200	21	40	8.1	32.7	24	<b>186 292</b>	<b>QSRL-G<sup>3</sup>/<sub>8</sub>-12</b>	<b>1</b>
G <sup>1</sup> / <sub>2</sub>	6.2	12	200	21	40	11.1	32.7	24	<b>186 293</b>	<b>QSRL-G<sup>1</sup>/<sub>2</sub>-12</b>	<b>1</b>

\* Packaging unit quantity