

Local controller DLP-VSE



- Local or remote controlled
- Operated manually or via superordinate PLC/fieldbus
- Protection class IP65
- Port pattern to Namur VDI/VDE3845

Local controller DLP-VSE

Technical data

This local controller is a convenient manual control unit for actuating the process drives. Using a local controller, a pneumatic drive can assume the functionality of an electrical drive.

- Can be mounted directly on the drive or on a wall
- Emergency compressed air connection
- Safe thanks to its key-operated switch with removable key
- Large, long-life fluorescent display for the open/closed position of the process valve
- Operated on site or remote-controlled



| General technical data | | |
|--|--------|--|
| Voltage supply without AS-interface | [V DC] | 24 -15/+20% |
| Voltage supply with AS-interface | [V DC] | 26.5 ... 31.6 |
| Ancillary voltage supply with AS-interface | [V DC] | 24 -15/+20% |
| Operating voltage at the valve | [V DC] | 24 -15/+20% |
| Duty cycle, solenoid coils | [%] | 100 |
| Protection class | | IP65 Plug connector when fully plugged-in or fitted with protective cover |

| Ambient conditions | | |
|--|------|--|
| Ambient temperature | [°C] | -5 ... +50 based on EN 60 654-1 class C1 (use in weather-protected areas) |
| Optional ambient temperature | [°C] | -25 ... +55 to EN 60 654-1 class C2 (use in weather-protected areas) |
| Relative air humidity | [%] | 5 ... 100 condensing |
| Corrosion resistance class CRC ¹⁾ | | 3 |

1) Corrosion resistance class 3 according to Festo standard 940 070
Components requiring higher corrosion resistance. External visible parts in direct contact with industrial atmospheres or media such as solvents and cleaning agents, with a predominantly functional requirement for the surface.

Local controller DLP-VSE

Technical data

Dimensions

Download CAD data → www.festo.com/en/engineering

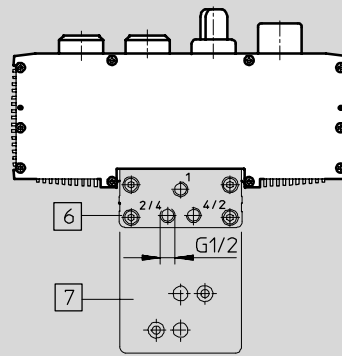
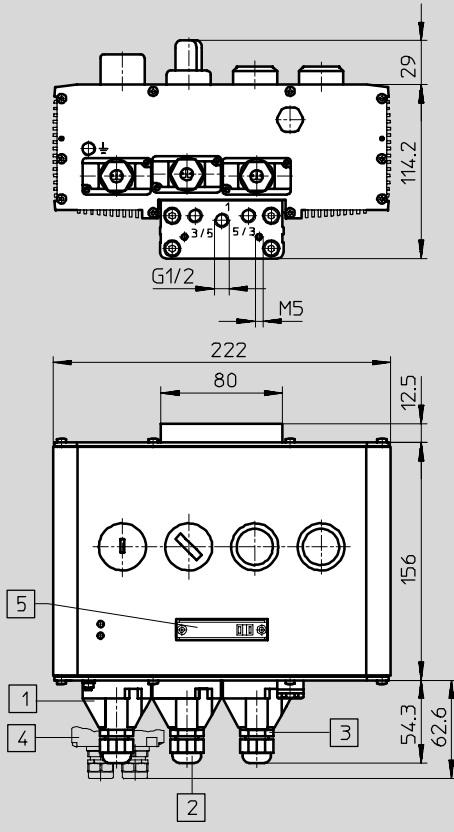

Fieldbus connection AS-interface

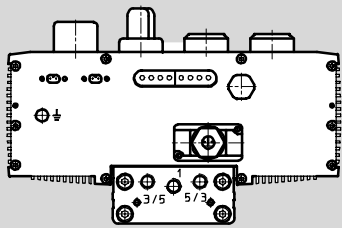

Fieldbus connection Profibus DP

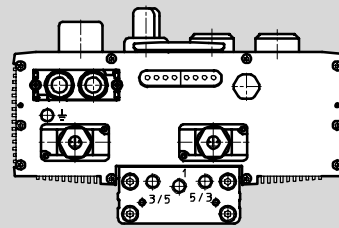

| | Stand-alone | Fieldbus connection | |
|--|------------------------------|------------------------------|------------------------------|
| | PLC | AS-interface | Profibus DP |
| 1 Power supply | ■ | - | ■ |
| 2 PLC connection or external controller | ■ | - | - |
| 3 Limit switch inputs | ■ | ■ | ■ |
| 4 Cable socket for AS-interface Plug, Sub-D | - | ■ → Accessories 7 / 3.1-5 | ■ → Accessories 7 / 3.1-5 |
| 5 Switch cover for addressing the Profibus-DP | - | - | ■ |
| 6 Sub-base DLP-VSE-OBEN for wall mounting | ■ Accessories → 7 / 3.1-5 | ■ Accessories → 7 / 3.1-5 | ■ Accessories → 7 / 3.1-5 |
| 7 Sub-base DLP-VSE-OBEN-NAMUR for mounting on the linear actuator DLP | ■ Accessories → 7 / 3.1-5 | ■ Accessories → 7 / 3.1-5 | ■ Accessories → 7 / 3.1-5 |

Local controller DLP-VSE



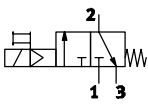
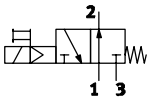
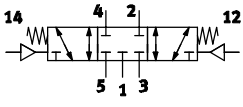





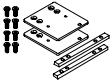

Technical data

| Ordering data | | | |
|---|---|----------|---------------------|
| | Brief description | Part No. | Type |
|  | integrated 5/2-way valve, normally closed | 188 463 | DLP-VSE-2-5/2-C |
|  | integrated 5/2-way valve, normally open | 188 466 | DLP-VSE-2-5/2-O |
|  | integrated 5/3-way valve, normally closed | 188 472 | DLP-VSE-2-5/3-G |
| | integrated 5/3-way valve, normally closed Fieldbus connection AS-interface | 188 473 | DLP-VSE-2-5/3-G-ASI |
| | integrated 5/3-way valve, normally closed Fieldbus connection Profibus DP | 188 474 | DLP-VSE-2-5/3-G-DP |

Local controller DLP-VSE

Accessories



| Ordering data | | | |
|---|--|----------|--------------------|
| | Brief description | Part No. | Type |
| Mounting | | | |
|  | Mounting kit for wall mounting in conjunction with the sub-base DLP-VSE-OBEN | 192 062 | DLP-VSE-BP |
|  | Sub-base in conjunction with mounting kit DLP-VSE-BP for tubing connection in the direction of the drive | 192 061 | DLP-VSE-OBEN |
|  | Sub-base for mounting on the linear actuator DLP | 192 060 | DLP-VSE-OBEN-NAMUR |
| Fieldbus connection | | | |
|  | Cable socket for AS-interface | 18 785 | ASI-FD-FK |
|  | Plug Sub-D for Profibus DP | 532 216 | FBS-SUB-9-GS-DP-B |
| Fittings | | | |
|  | Push-in fitting Male thread with internal hexagon | 153 015 | QS-1/8-8-1 |
|  | Barbed fitting High-alloy stainless steel with sealing ring | 13 967 | CRCN-M5-PK-3 |
| | Barbed fitting High-alloy stainless steel with sealing ring | 13 970 | CRCN-1/8-PK-4 |
|  | Quick connector Aluminium design with sealing ring for plastic tubing PL, PP, PU (10 per delivery unit) | 3 561 | CK-M5-PK-3 |
| | Quick connector Plastic design with moulded-on sealing ring for plastic tubing PL, PP, PU (10 per delivery unit) | 2 028 | CK-1/8-PK-6 |
| Silencers | | | |
|  | Sintered bronze (10 per delivery unit) | 4 645 | U-M5 |
|  | Polymer | 2 307 | U-1/8 |

