



- Vacuum does not dissipate when several suction cups are arranged in parallel
- Suitable for handling sacks of powdered material
- Gripping of randomly placed products
- Saves compressed air and energy

# Vacuum efficiency valves ISV

Features



## Areas of application

- For parallel arrangement of several suction cups
  - To prevent dissipation of the vacuum if one or several suction cups do not make full contact
- Handling sacks of powdered product
  - Unintentional dispersal of the product around the vacuum device is prevented
- Gripping of randomly placed products
- Saves compressed air and energy
  - Retention is only successful if 100% contact is achieved
- Maintains vacuum

## Function diagram

These valves are suitable for applications requiring several vacuum suction cups and for the maintenance of vacuum in the event that one suction cup should fail to make contact.

- 1 Vacuum generator
- 2 Distributor
- 3 Vacuum efficiency valve
- 4 Suction cup

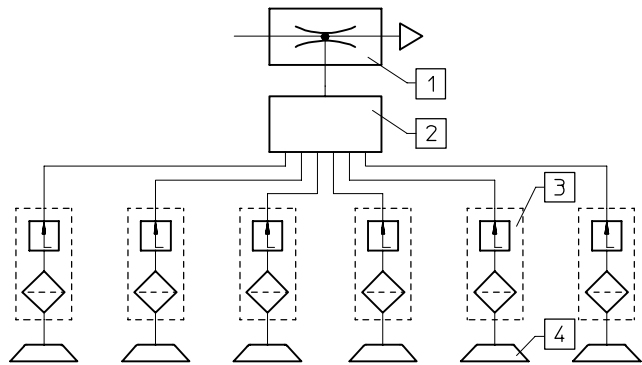

## Vacuum efficiency valve function

The ISV valve is fitted between the vacuum generator and the suction cup.

If, during vacuum generation, a suction cup is uncovered, or only partly covered, the ISV automatically stops the influx of air.

When the suction cup fits tightly against the surface, a vacuum is regenerated. Removal of the object from the suction cup causes the ISV valve to close immediately.

1. When the suction cup is open to atmosphere, the float is drawn back against the housing. In this position, flow is only possible through the small hole in the end of the float.
2. When an object is in contact with the suction cup, flow is reduced and the spring forces the float forward. The seal is thus broken and full vacuum is generated within the suction cup.

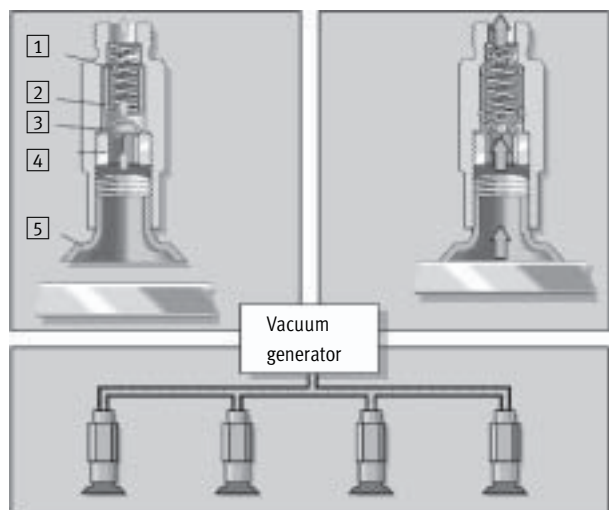



- 1 Spring
- 2 Float
- 3 Filter
- 4 Retaining screw
- 5 Suction cup

# Vacuum efficiency valves ISV

Technical data

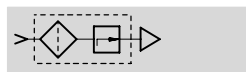
Function



-  - Temperature range  
-10 ... +60 °C

-  - Operating pressure  
4 ... 10 bar



General technical data				
Size	M5	G1/8	G1/4	G3/8
Operating medium	Atmospheric air			
Mounting position	Any			
Nominal size [mm]	0.4	0.4	0.4	0.7
Type of mounting	Screwed in between suction cup and distributor			
Pneumatic connection	M5	G1/8	G1/4	G3/8
Operating pressure [bar]	4 ... 10		5 ... 7	
Switched flow [l/min]	5	8	8	25

Ambient conditions				
Size	M5	G1/8	G1/4	G3/8
Ambient temperature [°C]	-10 ... +60			
Corrosion resistance CRC <sup>1)</sup>	2			

1) Corrosion resistance class 2 according to Festo standard 940 070  
Components requiring moderate corrosion resistance. Externally visible parts with primarily decorative surface requirements which are in direct contact with a surrounding industrial atmosphere or media such as cooling or lubricating agents.

Weights [g]				
Size	M5	G1/8	G1/4	G3/8
ISV-...	4	9	16	29

Materials				
Size	M5	G1/8	G1/4	G3/8
Housing	Galvanised steel		Anodised aluminium	
Filter	Sintered bronze		Aluminium-Niro housing	

# Vacuum efficiency valves ISV

Technical data



## Evacuation time $t$ as a function of the volume to be evacuated $V$ with various ejectors

ISV-...M5

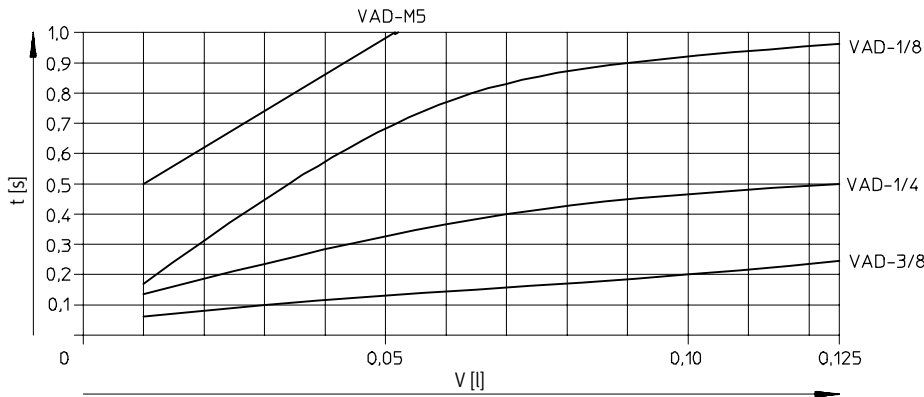

ISV-...1/8/ISV-...1/4

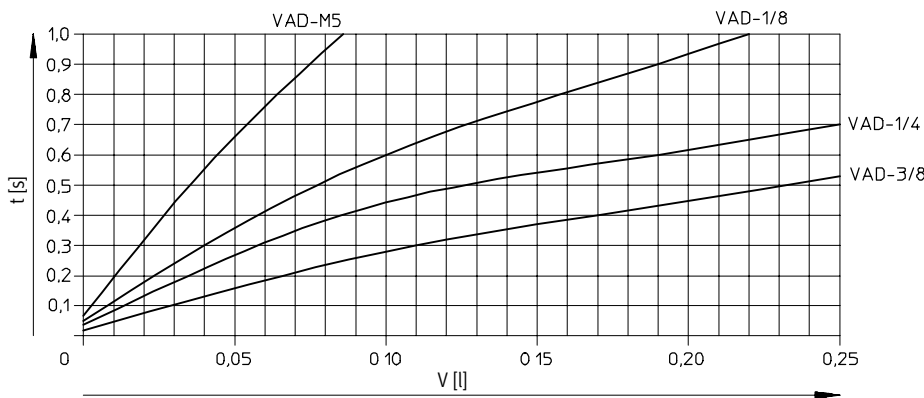

ISV-...3/8

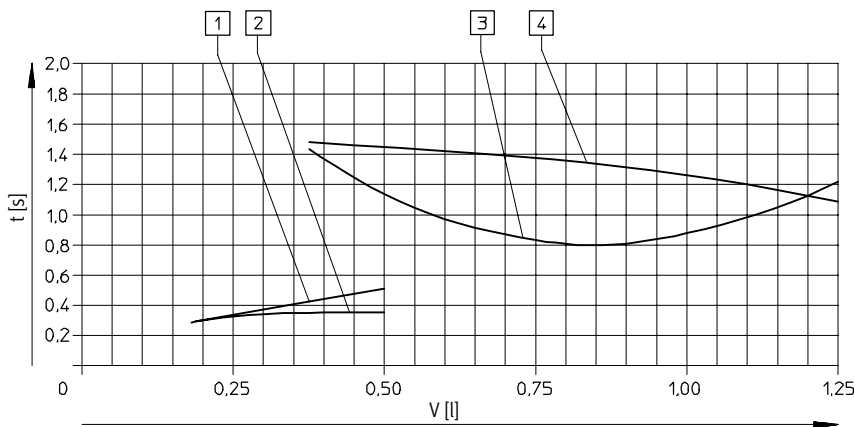

Evacuation time is the time required to attain 90% maximum possible vacuum.

- 1 VAD-...-3/8 with flat suction cup VAS-125-...
- 2 VAD-ME-...-3/8 with flat suction cup VASB-125-...
- 3 VAD-...-3/8 with bellows suction cup VASB-125-...
- 4 VAD-ME-...-3/8 with bellows suction cup VASB-125-...

# Vacuum efficiency valves ISV

Technical data

## Conditions for operation of the vacuum efficiency valve ISV

- The number of vacuum suction cups that can be attached depends upon the suction capacity of the ejector.
- A minimum switching flow rate is required to ensure the function of each ISV valve connected in parallel to an ejector.
- The number of cups which can be reliably operated can be estimated on the basis of the ratio of ejector suction power and the minimum switching flow rate of the ISV valve.

Max. number of suction cups sealed by ISV-... valves and remaining attainable vacuum in relation to type of ejector used (operating pressure: 6 bar)

Ejector	Max. number of suction cups at P <sub>u</sub> [bar]											
	ISV-M5			ISV-1/8			ISV-1/4			ISV-3/8		
	-0.5	-0.6	-0.7	-0.5	-0.6	-0.7	-0.5	-0.6	-0.7	-0.5	-0.6	-0.7
VAD-M5	2	1	-	1	1	-	1	-	-	-	-	-
VAD-1/8	4	2	1	2	1	-	2	1	-	-	-	-
VAD-1/4	8	6	3	4	3	1	4	3	1	-	-	-
VAD-3/8	8	8	7	7	6	3	7	6	3	-	2	1
VADM-45/VADMI-45	2	1	-	1	1	-	1	-	-	-	-	-
VADM-70/VADMI-70	4	2	1	2	1	-	2	1	-	-	-	-
VADM-95/VADMI-95	8	6	3	4	3	1	4	2	1	-	-	-
VADM-140/VADMI-140	8	8	7	7	6	3	7	6	3	3	2	1
VADM-200/VADMI-200	16	16	14	14	12	6	14	12	6	6	4	2
VADM-300/VADMI-300	32	32	28	28	24	12	28	24	12	12	8	4

# Vacuum efficiency valves ISV

Technical data

FESTO

## Dimensions

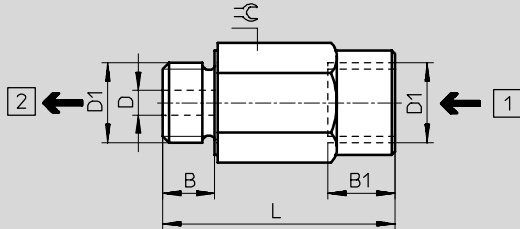

- 1 Suction side
- 2 Tubing side

Type	B	B1	D ∅	D1 ∅	L	⊕
ISV-M5	5	5.5	2	M5	15	8
ISV-1/8	6.5	11	4	G1/8	36	13
ISV-1/4	8	11	4	G1/4	38	17
ISV-3/8	9	13	4	G3/8	39	22

## Ordering data

Pneumatic connection	Part No.	Type
M5	151 217	ISV-M5
G1/8	33 969	ISV-1/8
G1/4	33 970	ISV-1/4
G3/8	33 971	ISV-3/8
Free of copper, PTFE and silicone		
M5	183 520	ISV-M5-CT